

Part D

Design Guidelines

9.0 Guidelines for Buildings and Surroundings

In its history and character, Maple is a distinct place in the larger municipality of the City of Vaughan. The City has recognized this special character by creating the Village of Maple Heritage Conservation District.

The purpose of these Design Guidelines is to help maintain the historic qualities that make up that sense of distinctness. They are intended to clarify and illustrate, in a useful way, the recognizable heritage characteristics found in the Village. They will serve as a reference for anyone contemplating alterations or new development within the Heritage Conservation District.

The Guidelines examine the past in order to plan for the future. They recognize that change must and will come to Maple. The objective of the Guidelines is not to prevent change, but to ensure that change is complementary to the heritage character that already exists, and enhances, rather than harms it.

Guidelines:

- The intent of the Guidelines is to preserve and enhance the existing heritage character of Village of Maple, which is widely appreciated by the citizens
- It is recommended that design professionals with experience in heritage design and restoration be retained for work on significant heritage buildings in the District.



Looking south on Keele Street, with St. Stephen's Anglican Church on the left. Photograph from Vaughan Archives.

9.0 Guidelines for Buildings and Surroundings

The character of Maple consists of many elements:

Significant natural features include the park, a small tributary of the West Don River, the open spaces of the cemeteries and church yards, and the mature urban forest.

Significant cultural elements include the informal village plan, with its varied lot sizes and setbacks, rich planting, and almost 150 years of architectural history. The historic buildings serve to define the heritage character of the village.

These Design Guidelines are based on the concepts of preserving the existing heritage buildings, maintaining their character when they are renovated or added to, and ensuring that new development respects the qualities of place established by the existing heritage environment.

The Guidelines begin with a handbook of the architectural styles found in Maple. Over the years, many buildings have lost original detail such as trims, doors, and windows. The style book will be helpful to owners who want to restore original character, or who want to maintain what remains. It will assist in designing additions that respect the original style of the building. And it will provide a basis for **authentic** local historic references in the design of new buildings.

The stylebook is also a tool for looking at the existing heritage buildings, which offer the best guidelines of all: they are full-scale and in three dimensions. The best test of new work in the Village is whether or not it shows “good manners” towards its heritage neighbours and its neighbourhood.

The design Guidelines are divided into the following sections:

- 9.1 Architectural Styles, p. 58
- 9.2 Heritage Design & Details, p. 81
- 9.3 Existing Heritage Buildings, p. 94
 - Maintenance
 - Renovation
 - Additions
- 9.4 Existing Non- Heritage Buildings, p. 108
- 9.5 New Development, p. 110
 - Residential Areas
 - Commercial Core
- 9.6 Streetscape Work, p. 125
- 9.7 Landscapes, p. 132
- 9.8 Building Materials Checklists, p. 134

Architectural style means the identifying characteristics of construction as it has evolved under the force of changing technology and fashion. Before the industrial age, often minor details were custom-made for each building and it would be hard to find even two identical front door designs from the early 19th century.

Nonetheless, each period produced buildings that shared a design vocabulary, including elements of massing, composition, proportions, window and door details, and decorative elements. This section shows the principal styles that have appeared in Maple, both heritage styles and more recent ones. This section is necessarily brief and does not replace the real research needed for authentic work, as described in Section 9.3.2 and 9.5.1.

In the Guidelines that follow, reference is made to architectural styles for all types of buildings in the Village of Maple: existing heritage buildings, existing non-heritage buildings, and new development. The following pages show the characteristics of the local architectural styles.

Guideline:

Additions and alterations to an existing heritage building should be consistent with the style of the original building. New developments should be designed in a style that is consistent with the vernacular heritage of the community. All construction should be of a particular style, rather than a hybrid of many styles. Recent developments have tended to use hybrid designs, with inauthentic details and proportions; for larger homes, the French manor or *château* style (not indigenous to Ontario) has been heavily borrowed from. These kinds of designs are not appropriate for the Village of Maple.

9.1 Architectural Styles

9.1.1 Heritage Styles Residential Buildings

VERNACULAR “LOYALIST” COTTAGE 1800-1850

Kitchen Tail often added later, sometimes with a side porch.

Fieldstone foundations

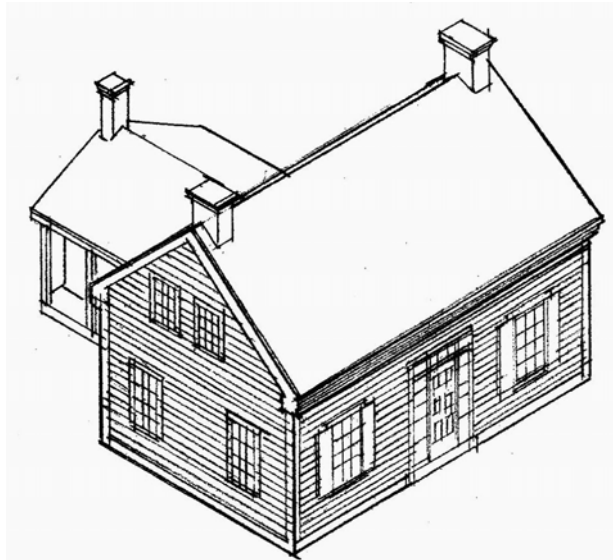

Brick chimneys, sometimes central

4" wood clapboard siding with wood corner boards; Brick or stone in some areas.

Wood fascia and eaves.

Symmetrical façade; central door with transom and/or sidelights.

Wood windows, double hung, 6 over 6 or greater.

Optional wood shutters.

The first of rural Ontario’s two ubiquitous styles, the other being the Ontario Gothic Vernacular. The 1-1/2 storey design avoided the heavier taxation applied to 2-storey houses.

Typical Design Elements: for more information see Section 9.2

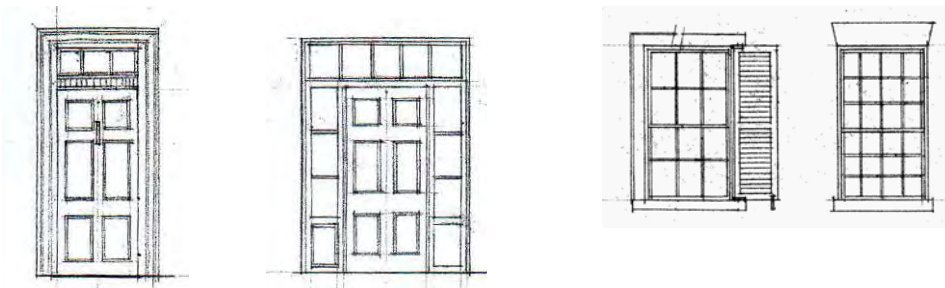

8 Church Street

9.1 Architectural Styles

9.1.1 Heritage Styles Residential Buildings

NEO-CLASSICAL 1800-1830

Side gable roof with moderate slope

Brick chimneys at side walls

Fieldstone Foundation

Symmetrical front elevation

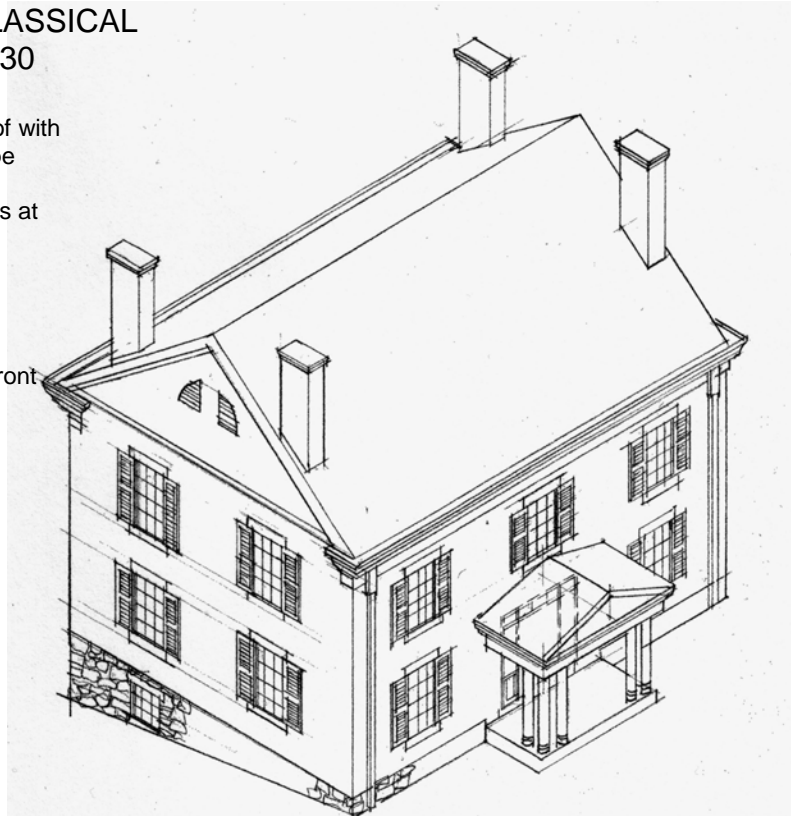

Usually brick or stone construction, less often wood clapboard.

Wood double-hung windows, often 12 over 12, tending to be larger than in Georgian style.

Classical details, such as pilasters at the corners, and "temple front" porch with classical columns.

Entry with sidelights and transom, often a fanlight. Classical surround is common.

Typical Design Elements: for more information see Section 9.2

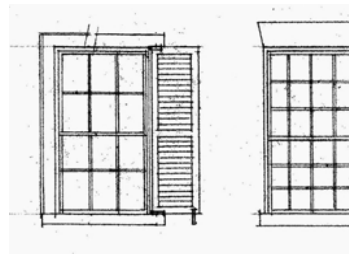
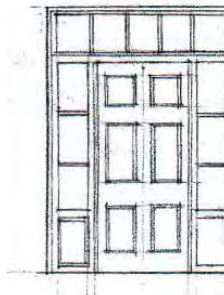
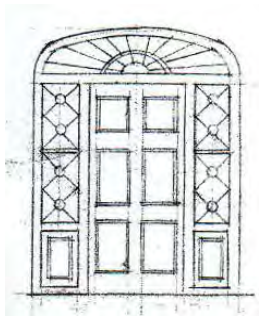

Beaverbrook House

9.1 Architectural Styles

ONTARIO GOTHIC VERNACULAR 1830-1890

- Kitchen Tail with room over.
- Wood side porch with sheet metal roof.
- Wood porch posts with decorative brackets.
- Fieldstone foundations.
- Red brick masonry with buff brick detailing—sometimes the reverse (polychromy).
- Optional front verandah, often with bell-cast roof.

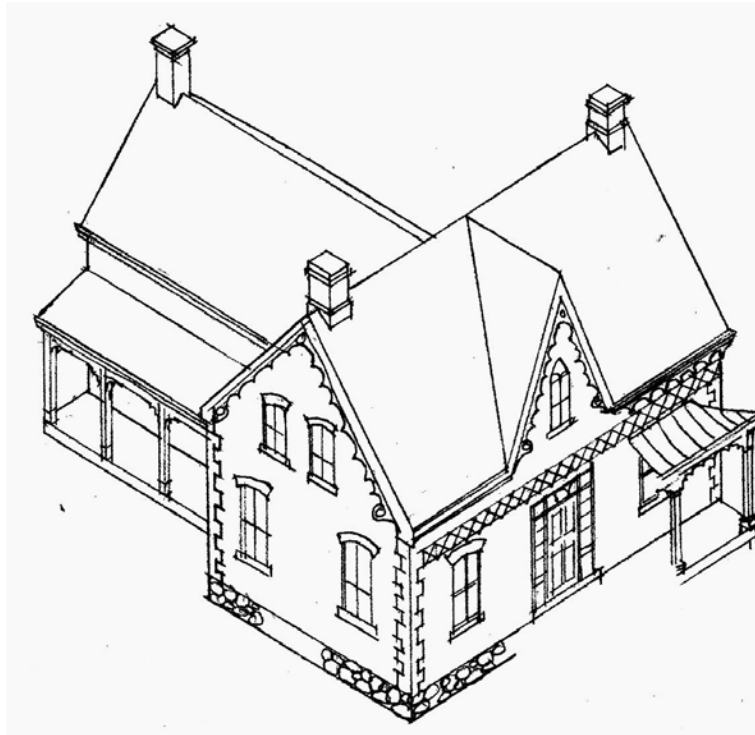

Brick chimney, corbelled polychrome.

Steep roof with “gingerbread” trim at gables; wood shingles or sheet metal roofing; Pointed ‘gothic’ window in central dormer gable.

Archetypal Ontario Gothic house, 1 ½ storeys, commonly brick construction, but also built of stone, stucco, and board and batten wood siding.

Symmetrical façade; central door with transom and/or sidelights.

Segmental arch wood windows, double-hung, 2 over 2.

9.1.1 Heritage Styles Residential Buildings

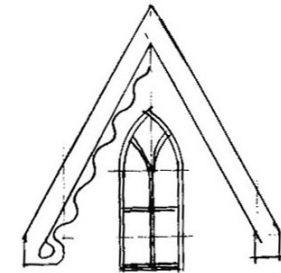

The central dormer is the most persistent feature in Ontario vernacular design. It is with us still. People will move into a bungalow and install a little peak in the verandah, above the front door. It makes the place feel more like home.

Typical Design Elements: for more information see Section 9.2

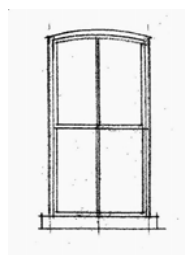
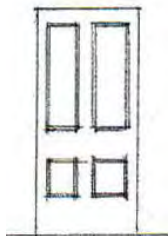

2150 Major Mackenzie Drive

9.1 Architectural Styles

VICTORIAN VERNACULAR 1850-1880

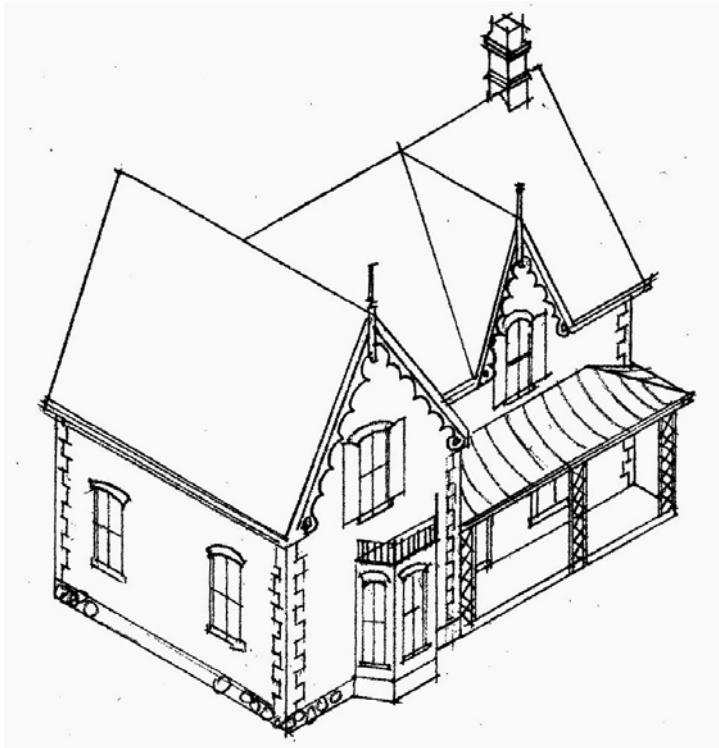

Brick chimney, corbelled polychrome.

Steep roof with "gingerbread" trim at gables; wood shingles or sheet metal roofing; Pointed 'gothic' window in central dormer gable.

Polychrome brick construction or board and batten siding (Carpenter Gothic).

Asymmetrical façade, main front-gabled bay often has a bay window.

Segmental arch windows, 2 over 2; optional shutters.

Verandah with wood posts and decorative brackets, or trelliage.

9.1.1 Heritage Styles Residential Buildings

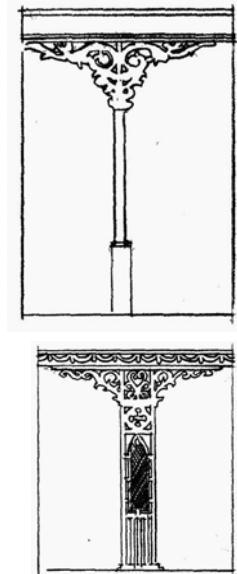

Typical Design Elements: for more information see Section 9.2

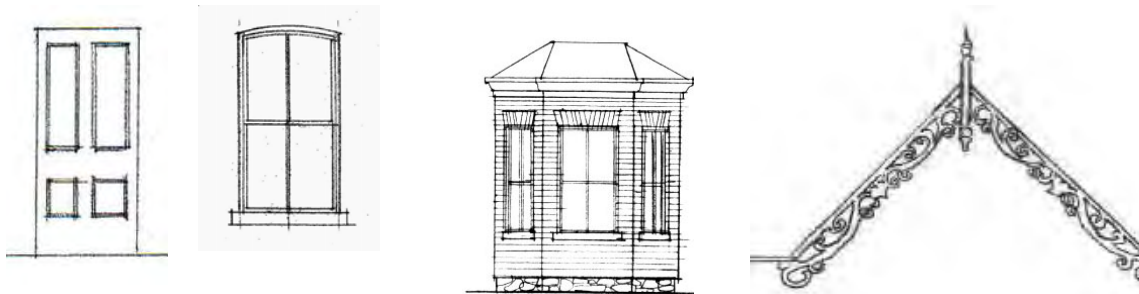

1 Jackson Street

9.1 Architectural Styles

SECOND EMPIRE
1855-1880

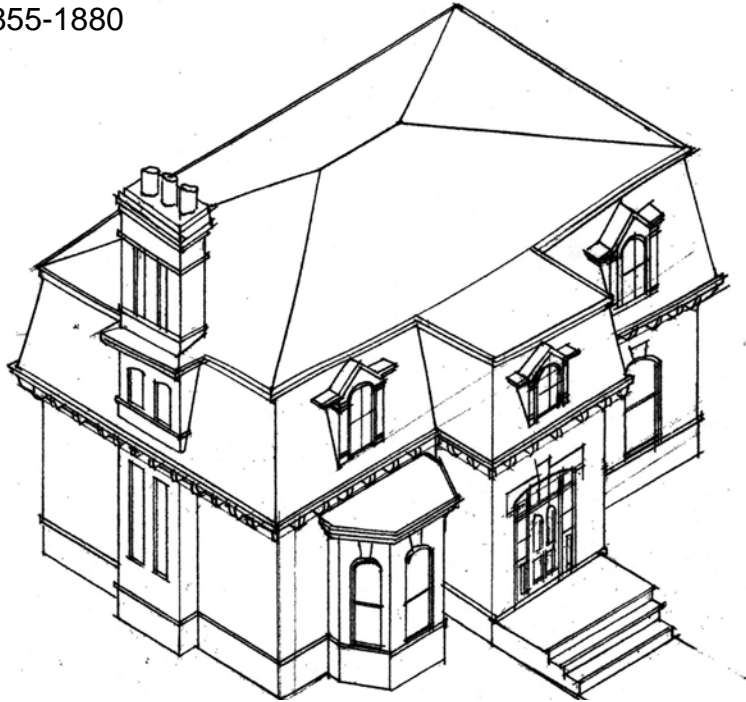

Mansard roof in shingle or slate.

Elaborately detailed dormers.

Decorative masonry work.

Large brackets at eaves.

Round-head or segmental-arched double-hung wood windows. 1 over 1 or 2 over 2.

Bay windows.

9.1.1 Heritage Styles Residential Buildings

Typical Design Elements: for more information see Section 9.2

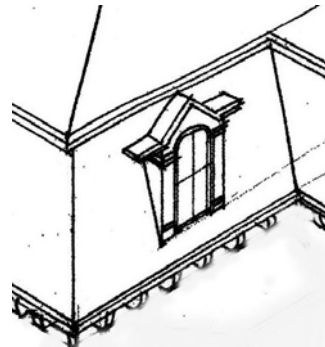
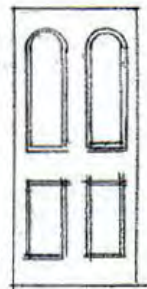
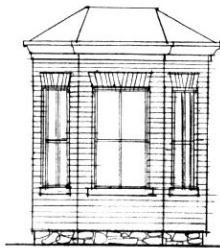

2333 Major Mackenzie Drive

9.1 Architectural Styles

9.1.1 Heritage Styles Residential Buildings

QUEEN ANNE REVIVAL 1885-1900

Steep gabled roof, often 12:12 slope.

Slate shingles often patterned.

Elaborate wood brackets, wood lattice work.

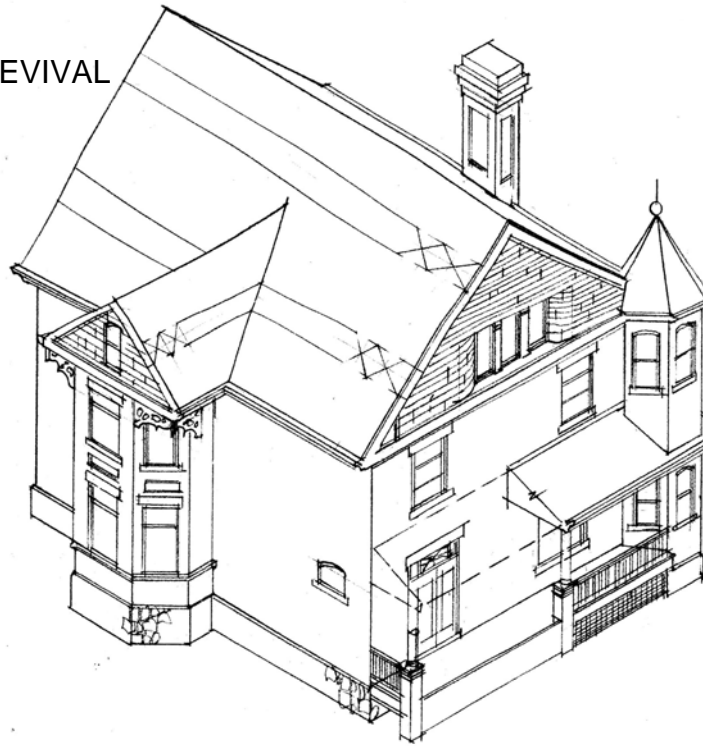

Brick construction.
Brickwork elaborately detailed.

Gable ends of shingles or tiles, often patterned.

Wide use of patterns in shingles, brickwork, and woodwork.

Asymmetrical plan, with turrets and bay windows.

Large double-hung windows, often with short upper sash.

Leaded and/or stained glass in transoms and upper sash..

Front porch or verandah.

Typical Design Elements: for more information see Section 9.2

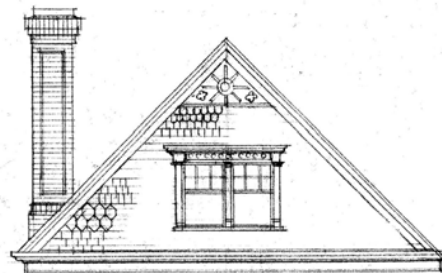
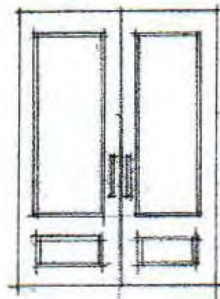
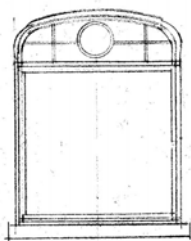

2126 Major Mackenzie Drive

9.1 Architectural Styles

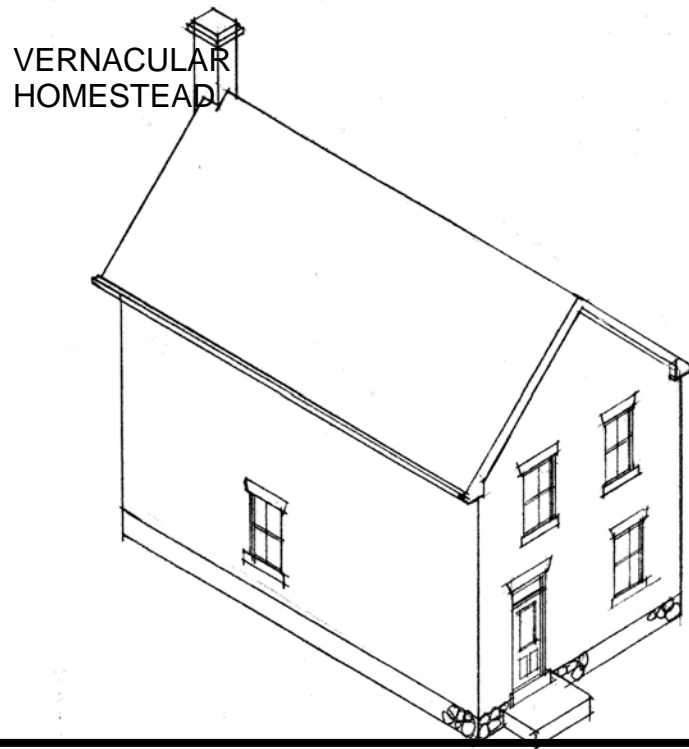

9.1.1 Heritage Styles Residential Buildings

Front-facing gable with steep roof, 12:12.

Two bays wide, with entrance and stair to one side. Plan has greater depth than width.

Detailing is simple.

Full-width verandah is common

Square headed openings.
Double-hung windows, 1/1 or 2/2.

May be clapboard, brick or stucco.

Typical Design Elements: for more information see Section 9.2

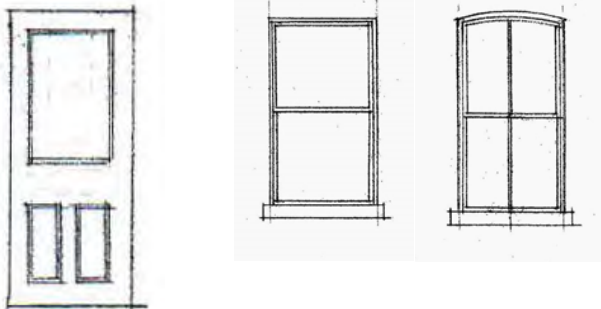

9.1 Architectural Styles

9.1.1 Heritage Styles Residential Buildings

Four-square 1900-1920

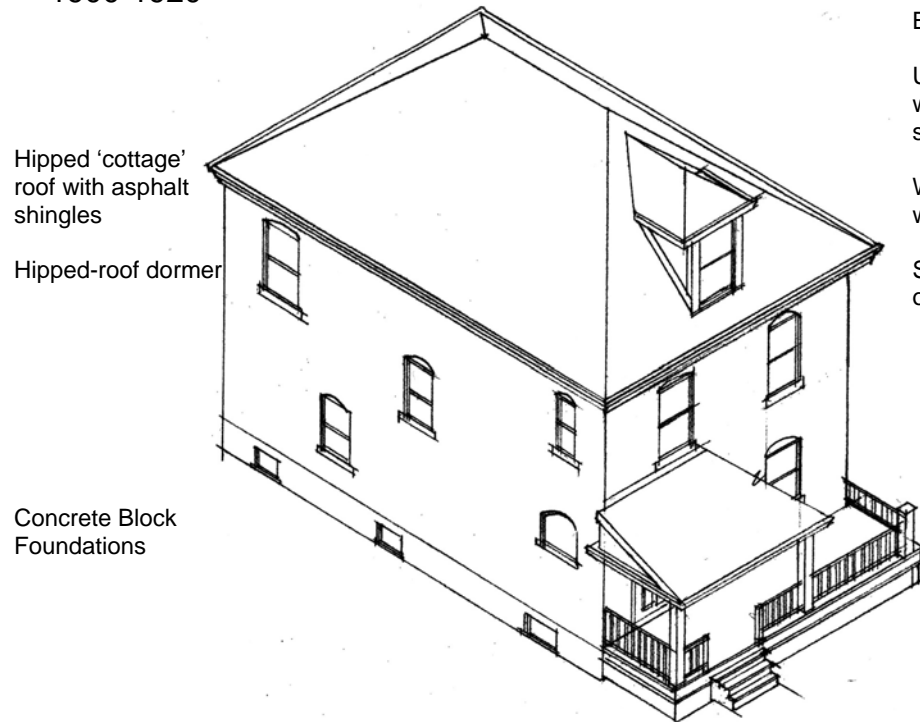

- Brick construction.
- Usually 2 bays wide with entrance to one side.
- Wood double-hung windows, 1 over 1.
- Simple wood porch or verandah.

Typical Design Elements: for more information see Section 9.2

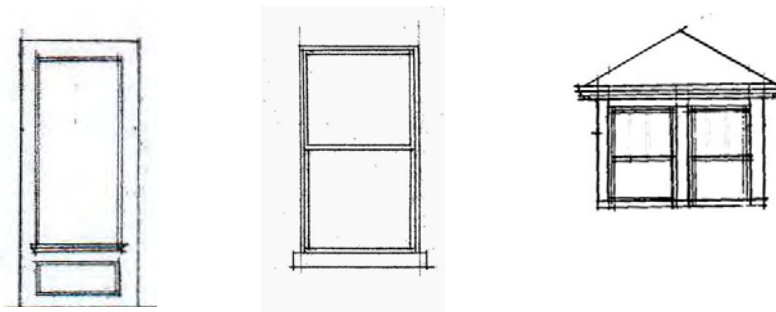

10104 Keele Street

9.1 Architectural Styles

Edwardian
Classic
1900-1920

Low-slope hipped
'cottage' roof with
asphalt shingles

Hipped-roof dormer
or low-slope gable
in attic.

Non-symmetrical
Plan and Façade.

Concrete Block
Foundations

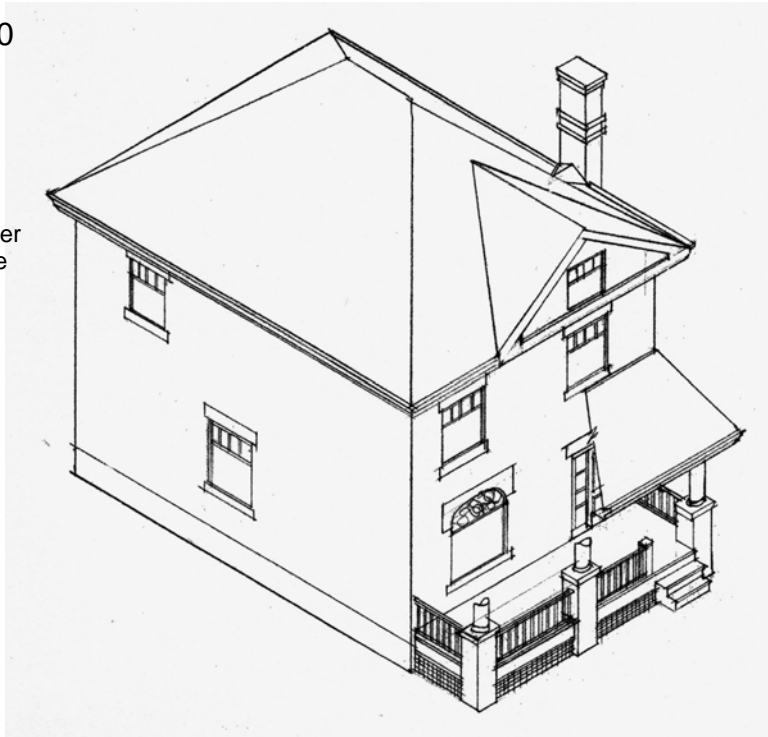

Brick construction.
Elaborate brickwork.

Wide wood double-
hung windows, often
6 over 1
or 4 vertical over 1.
"cottage style".

Wood verandah with
classical columns on
brick piers

Main front room
window with
decorative transom
often with leaded
and/or stained glass.

9.1.1 Heritage Styles Residential Buildings

Typical Design Elements: for more information see Section 9.2

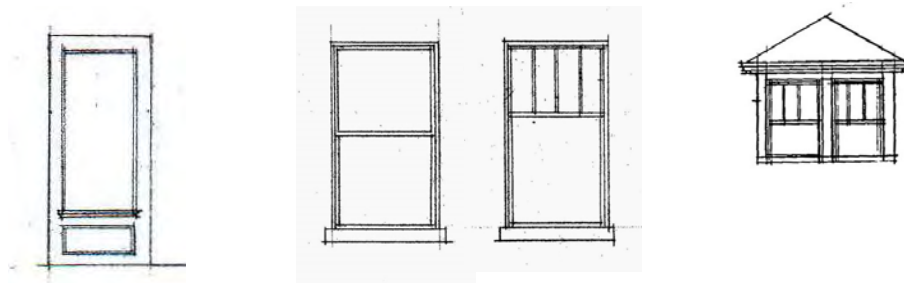

2174 Major Mackenzie Drive

9.1 Architectural Styles

A note on “Bungalows”.

The word “bungalow” has been applied to buildings of such a variety of sizes and shapes, that it causes architectural historians to shake their heads. John Milnes Baker, in his book *American House Styles*, says that bungalow is a type, not a style. In modern usage, the word has come to be used for almost any small house, regardless of its design. So there is some need to distinguish one kind of bungalow from another.

The term originates in a Hindi word meaning “house in the Bengal style”, and the originals were one-storey houses with low roofs and deep verandahs which provided needed airy shade in the heat of India.

The word entered the English language when the British in India adopted and elaborated the model for their army and colonial buildings, and they kept using the word as they built larger and fancier versions. The defining features remained the low roofs and the verandahs.

In North America, the term was first applied to small houses in the Craftsman style originally developed in California around 1900. These were 1- and 1-½ storey houses, with low-sloped roofs, wide eaves with the rafter tails exposed, and a deep front porch or verandah. Craftsman bungalow plans tended to be fairly open, with living and dining rooms flowing together, and perhaps a breakfast nook integrated with the kitchen.

The Craftsman bungalow was adopted as a model for mass-produced housing by builders across the continent between 1915 and 1930. The Builders’ bungalow retained the massing, but the Craftsman details were scaled back or eliminated.

By the late 1930s, “bungalow” had come to mean any small house that we don’t have another word for. The Cottage bungalow usually reverted to the hipped roof of the Bengali original, and in urban settings was sited with the narrow side facing the street. The Ranch bungalow (another California development) turned its long side to the street, on the larger lots of post-World War II suburbia.

The varieties of the North American bungalow are described in later sections below.



The original version of the bungalow, this one in Ceylon.



A British colonial bungalow in India, 1896.



A very grand early 20th Century Bungalow in India.

9.1 Architectural Styles

ARTS AND CRAFTS 1900-1930

Gable or "Jenkins-head" (partially hipped) roof.

Bay windows tend to be square.

Brick or Concrete Block Foundations

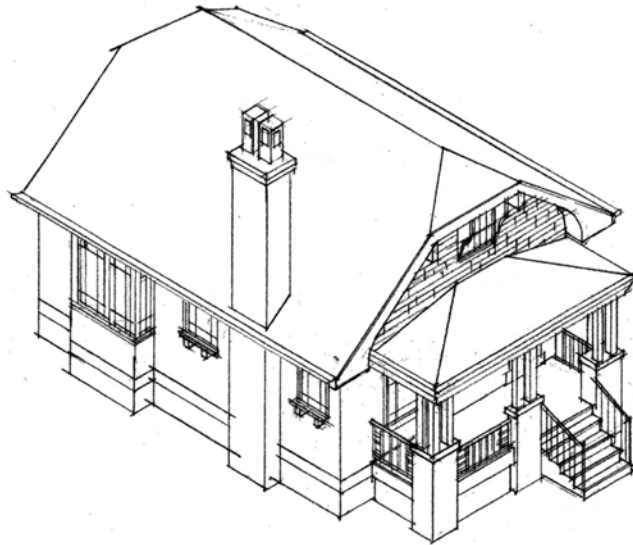

1 or 1-1/2 storey house.

Brick ground floor construction is common, with gable ends of cedar shingles

Asymmetrical plan, with entrance to one side.

Wood double-hung windows. Elaborate glazing patterns, sometimes leaded.

Verandah is a dominant design feature.

Rafter tails often exposed, and cut into decorative shapes.

9.1.1 Heritage Styles Residential Buildings

Typical Design Elements: for more information see Section 9.2

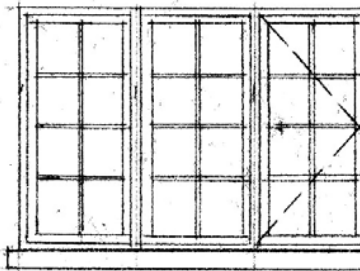

18 Richmond Street

9.1 Architectural Styles

9.1.1 Heritage Styles Residential Buildings

CALIFORNIA BUNGALOW 1900-1930

Side gable roof,
with long front
slope covering full
width verandah.

Wide front-gable
dormer.

Concrete block
foundation.

Non-symmetrical
Plan and Façade.

Concrete Block
Foundations

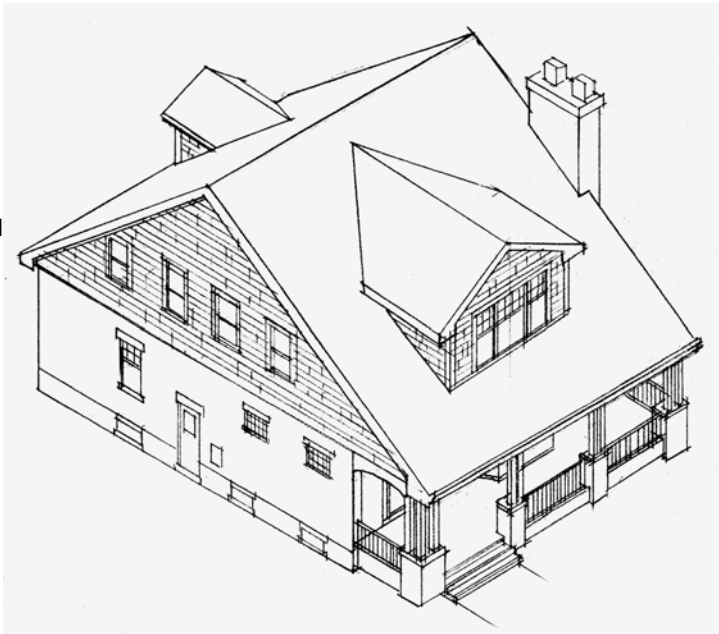

Usually brick ground
floor, with cedar
shingle gable ends
and dormers.

Verandah usually
supported by wood
columns on masonry
piers.

Wood double-hung
windows, often 6
over 1 or 4 vertical
over 1, "cottage
style".

Typical Design Elements: for more information see Section 9.2

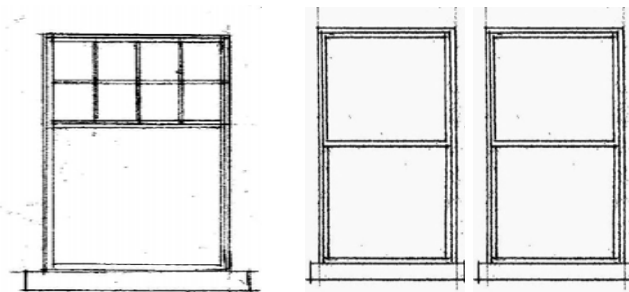

10128 Keele Street

9.1 Architectural Styles

AMERICAN COLONIAL REVIVAL 1900-1950

Steep gable roof.

Variety of roof plans, with front-gable bays or dormers.

Concrete Block Foundations

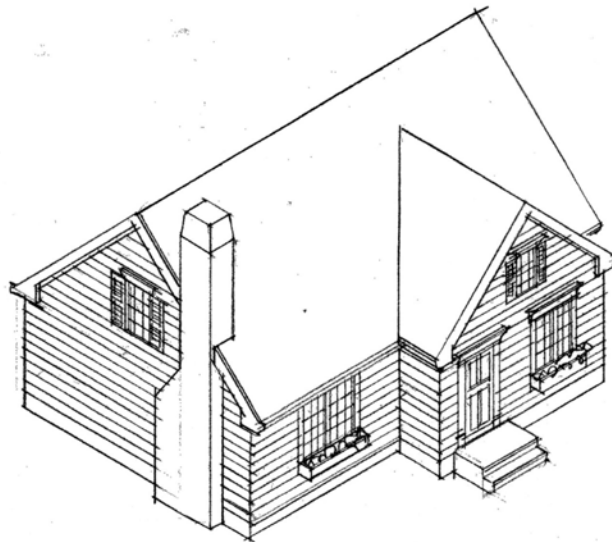

1 to 2 storey houses, often with asymmetrical plan.

Brick, clapboard or shingle siding.

Wood double-hung Georgian windows, often 6 over 6 or 8 over 8. Windows often paired.

Detailing fairly faithful to Georgian precedents..

9.1.1 Heritage Styles Residential Buildings

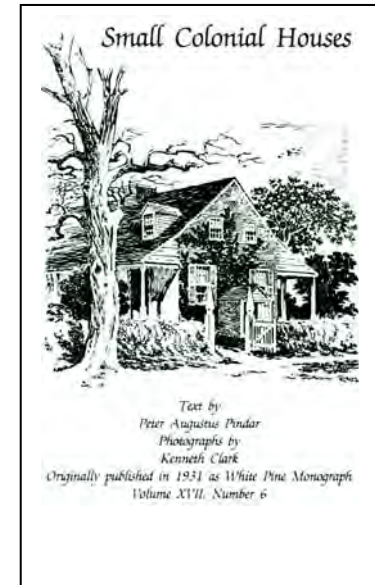

Typical Design Elements: for more information see Section 9.2

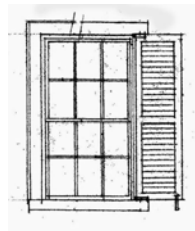
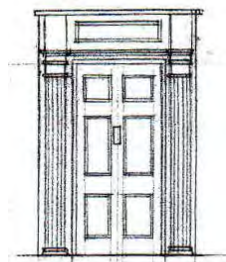

9.1 Architectural Styles

9.1.1 Heritage Styles Residential Buildings

DUTCH COLONIAL
REVIVAL
1900-1930

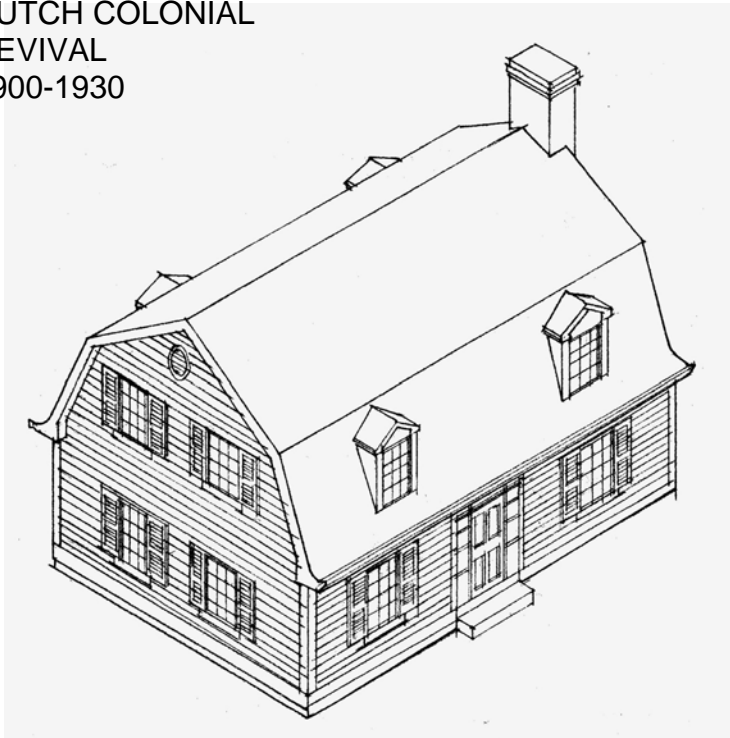

Usually 1-1/2 storeys, brick or wood clapboard siding.

Gambrel or “barn” roof provides increased second floor area. Often wood shingles.

Centre-hall symmetrical plan is common..
Asymmetrical plan, with gambrel-end facing the street, used on narrow lots.

Dormers, sometimes also with gambrel shape.

Wood double-hung windows, 6 over 6, wood shutters..

Typical Design Elements: for more information see Section 9.2

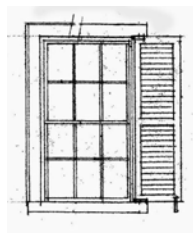
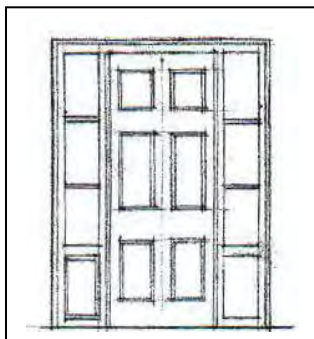

10108 Keele Street

9.1 Architectural Styles

"VICTORY" HOUSE 1939-1955

Classic mid-20th Century starter home, strongly derived from New England, hence Loyalist cottages.

Steep gable roof, 12:12, with asphalt or asbestos shingles.

May have gable dormers for upper floor, shed dormers often added later.

Foundations often on piles, with basements excavated later.

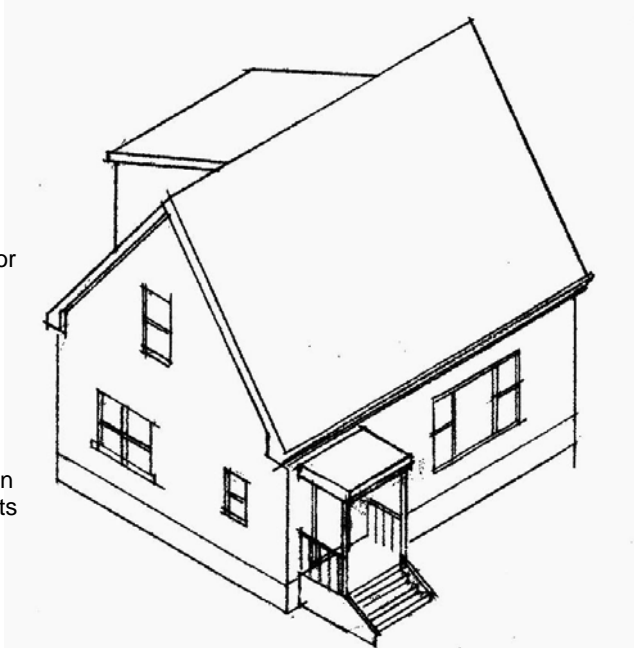

Variety of materials used:
Brick, stucco, clapboard, or asbestos siding.

Often large fixed 'picture' window flanked by narrow double-hung windows 1 over 1.

Compact plan 600 to 900 square feet. Non-symmetrical plan with entrance door to the side is usual in small plans. Larger plans may have centre door and centre hall.

Often a small entrance porch.

9.1.1 Heritage Styles Residential Buildings

This modest and stripped-down version of the Cape Cod cottage was produced in the thousands. Many were built near factories during the Second World War to house workers for the war effort that created Canada's manufacturing base. After the war, returning veterans built many more on their \$5000 housing allocation from the Department of Veteran's Affairs (DVA).

Typical Design Elements: for more information see Section 9.2

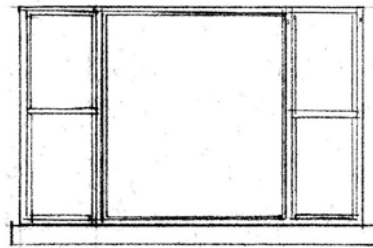
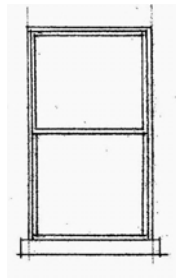

9.1 Architectural Styles

HOTELS AND INNS 1850-1880

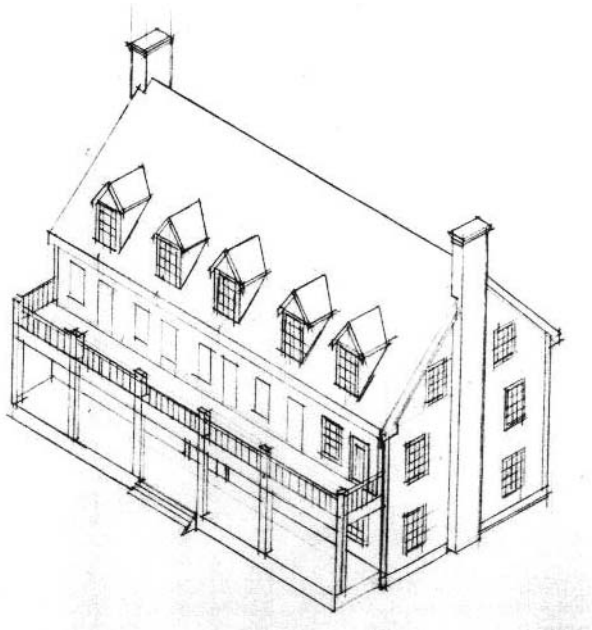

Usually 2 or 3 storeys with full-width front porch—commonly with balconies above

Usually frame construction in villages, sometimes brick in larger towns.

Side-gable roof was most common, with optional dormers.

Usually there was a stable alongside, for the travellers' horses and wagons .

9.1.2 Heritage Styles Commercial Buildings

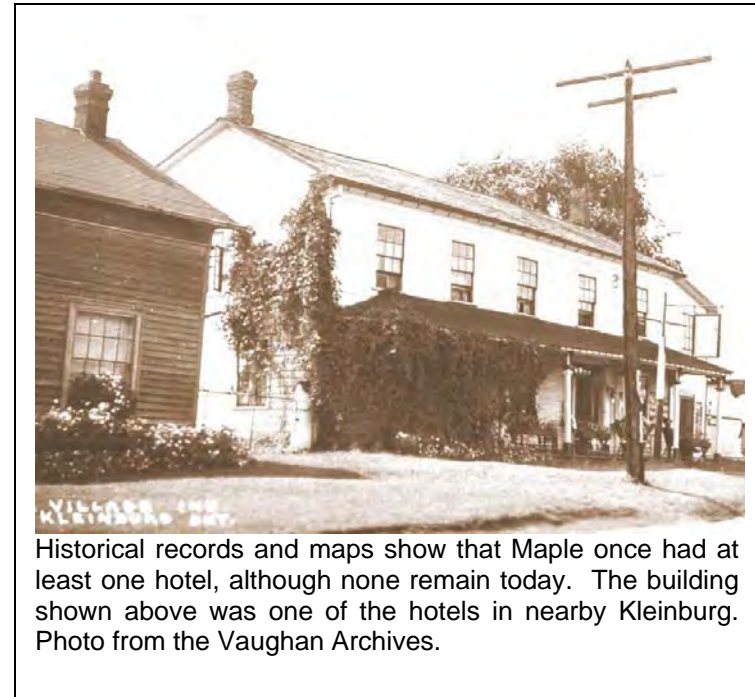

Historical records and maps show that Maple once had at least one hotel, although none remain today. The building shown above was one of the hotels in nearby Kleinburg. Photo from the Vaughan Archives.

9.1 Architectural Styles

VERNACULAR VILLAGE SHOP 1850-1910

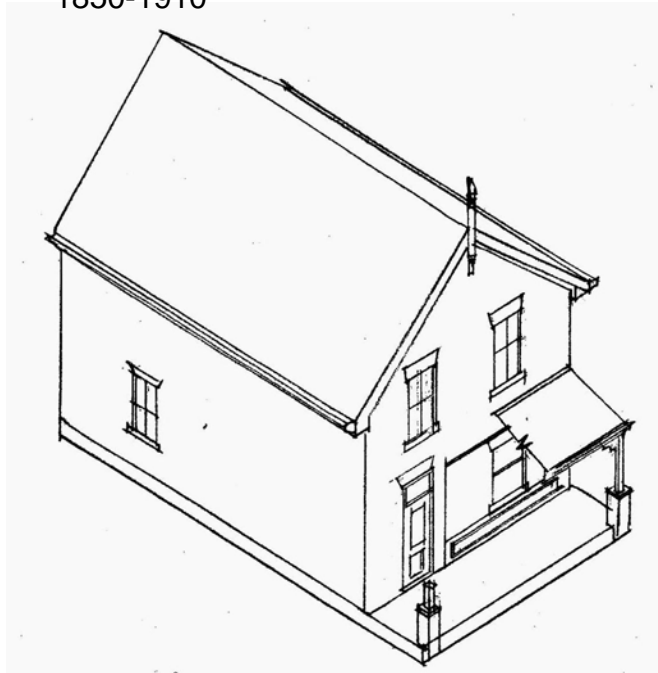

Usually a front-gabled frame building, similar to a homestead house. Often built with a false-front (boomtown style).

Typically built with shop below and living quarters above or behind.

Display window ranged from a slightly wider ordinary window, to a full-fledged shop-front as found in town shops.

Front porch, perhaps with sign on top, was very common.

9.1.2 Heritage Styles Commercial Buildings

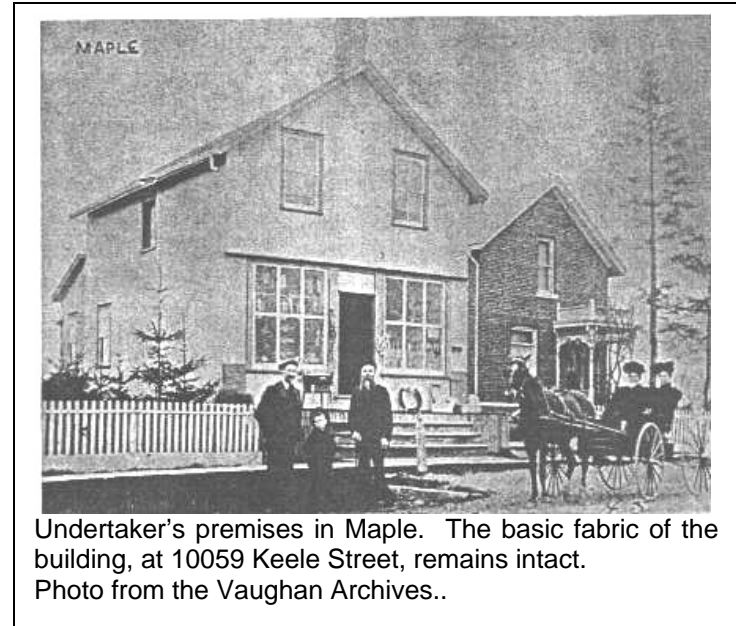

Typical Design Elements: for more information see Section 9.2

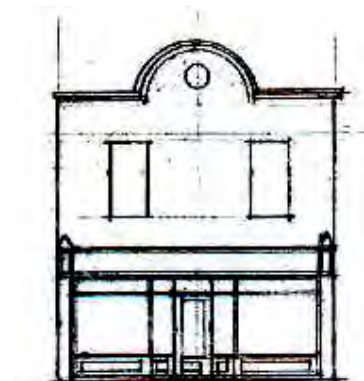
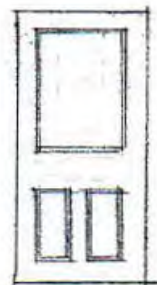
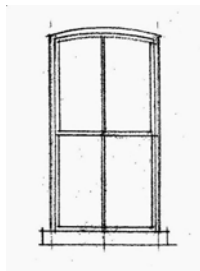

9.1 Architectural Styles

VERNACULAR TOWN SHOP 1880-1910

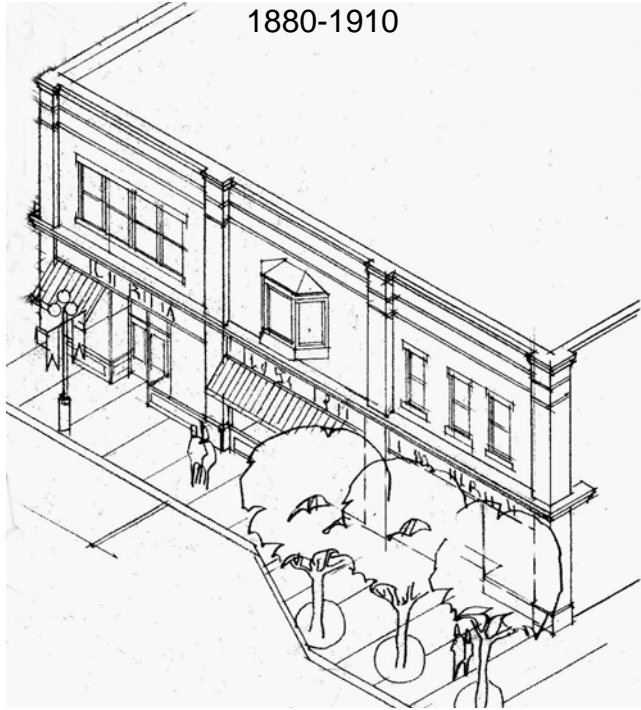

Two to three-storey buildings.

Early town shops might be wood-framed, but brick construction was more common by 1880, after many town fires throughout Ontario.

Built with uniform frontage at the street line.

Usually with flat roofs, sometimes with shallow side gable design.

Taller ground floor with high display windows, and full-width sign fascia above. Large retractable awnings.

9.1.2 Heritage Styles Commercial Buildings



The Bailey Store. A false front on a gabled village shop mimics the form of a town shop. Photo from the Vaughan Archives.

Typical Design Elements: for more information see Section 9.2

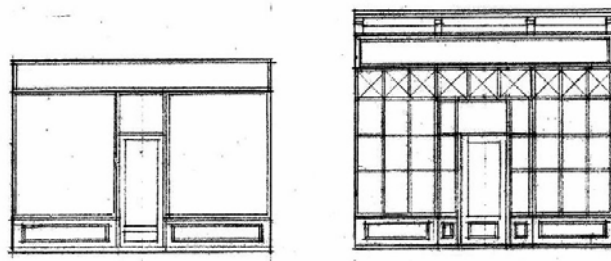

Lawrie Store 9994 Keele Street, with the Lawrie house behind.

9.1 Architectural Styles

GABLE- ROOFED TOWN-BARN OR STABLE SHOP 1850-1920

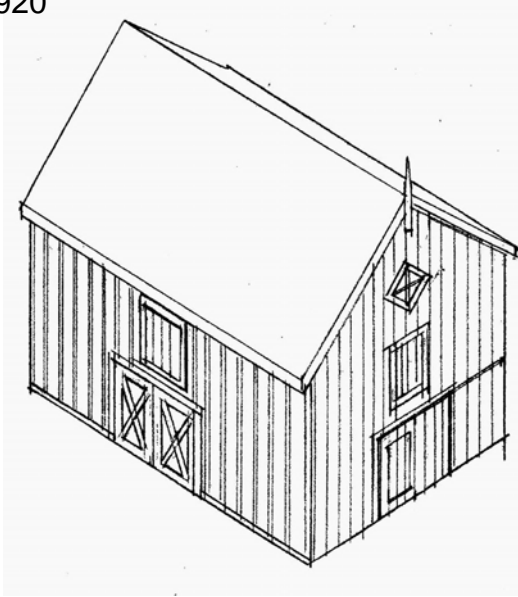

High-slope roof, wood shingle or sheet metal.

Timber frame with vertical wood siding, often slightly spaced for ventilation. Sometimes board and batten.

Upper loading door for hayloft. Sliding or hinged main lower doors, often with a smaller "man door" within it.

9.1.3 Heritage Styles Agricultural Buildings



Barn behind 9986 Keele Street

9.1 Architectural Styles

VERNACULAR BUNGALOW 1900-1955

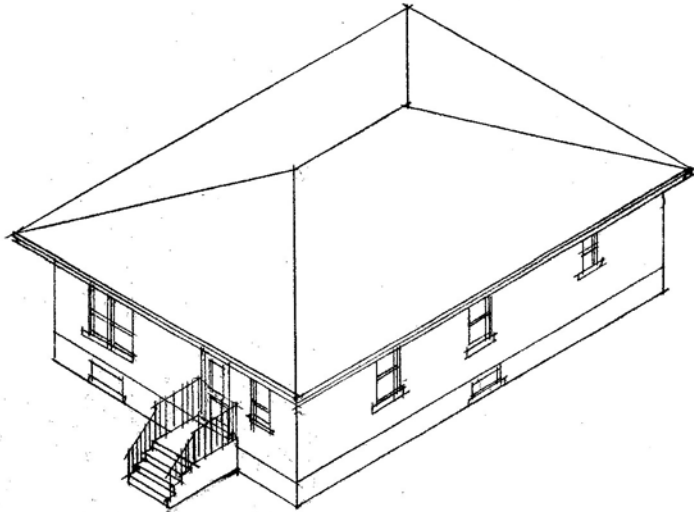

Usually of brick construction.

Wood double-hung windows, usually 1 over 1. Sometimes paired. Living room often had a "picture" window, with a wide fixed-glass window flanked by 2 narrow double-hung windows.

See "A note on bungalows", page 68.

9.1.4 Non-Heritage Styles Residential Buildings

Typical Design Elements: for more information see Section 9.2

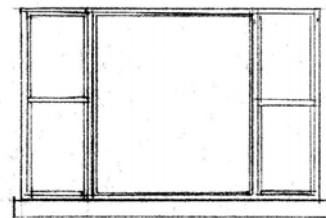
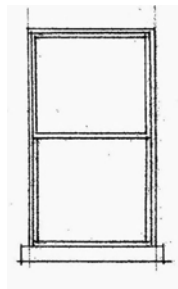

2146 Major Mackenzie Dr

9.1 Architectural Styles

RANCH HOUSE 1950-1975

9.1.4 Non-Heritage Styles Residential Buildings

Low slope roof, 4:12, hipped or gabled.

Asphalt Shingles.

Wide eaves, with 2-4 foot overhang

Large Chimney

Often accent bands of stone or 'angel stone'.

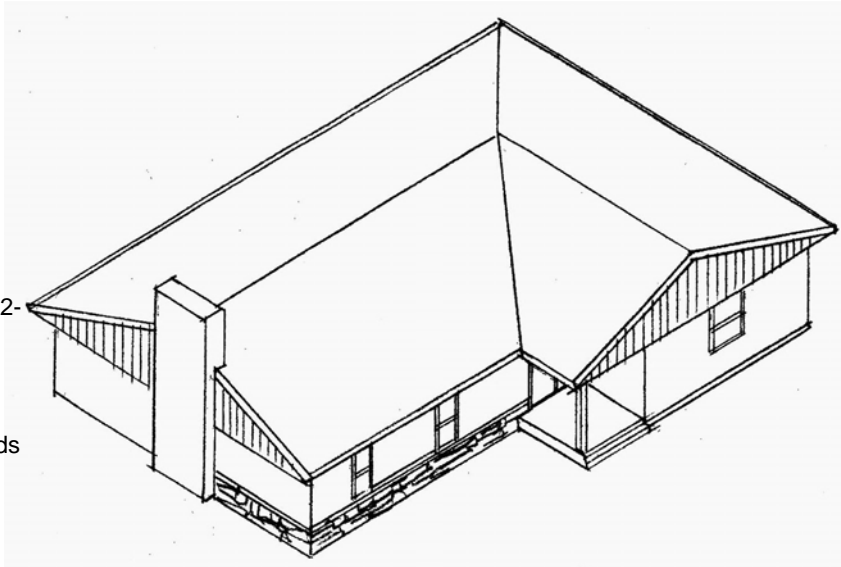

One-storey, informal plan.

Garage or carport usually attached.

Usually brick veneer on frame construction.

Large fixed picture windows in principal rooms, flanked by operable windows; double hung or casement.

Typical Design Elements: for more information see Section 9.2

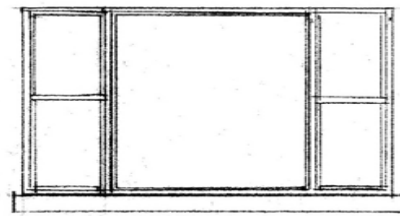
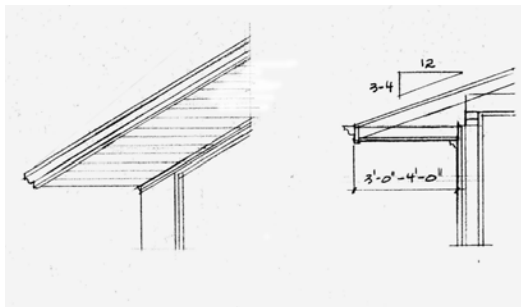

10138 Keele Street

9.1 Architectural Styles

POST MODERN ECLECTICISM 1980 TO PRESENT

9.1.4 Non-Heritage Styles Residential Buildings

Large high-sloped roof.

Usually two storeys high.

Elaborate chimneys are common.

Architectural elements borrowed from a variety of historical style. Elements are typically exaggerated in scale, particularly entrances, fanlights, and porches.

Mixture of materials: Stone base with brick or stucco above is common.

Attached or built-in garages are common.



9652 Keele Street

9.2 Heritage Design and Details

9.2.1 Introduction

The purpose of this Section is to provide further information and guidance about the design and construction of heritage buildings.

9.2.2 Composition

The elevations of heritage buildings, whether designed by an architect or by a builder using a “pattern book”, were usually laid out using geometrical principles and geometrically derived proportions. Knowledge of how heritage buildings were originally composed can be helpful in designing a new building that will fit well in the heritage context. Helpful sources of information are listed in Section 10.

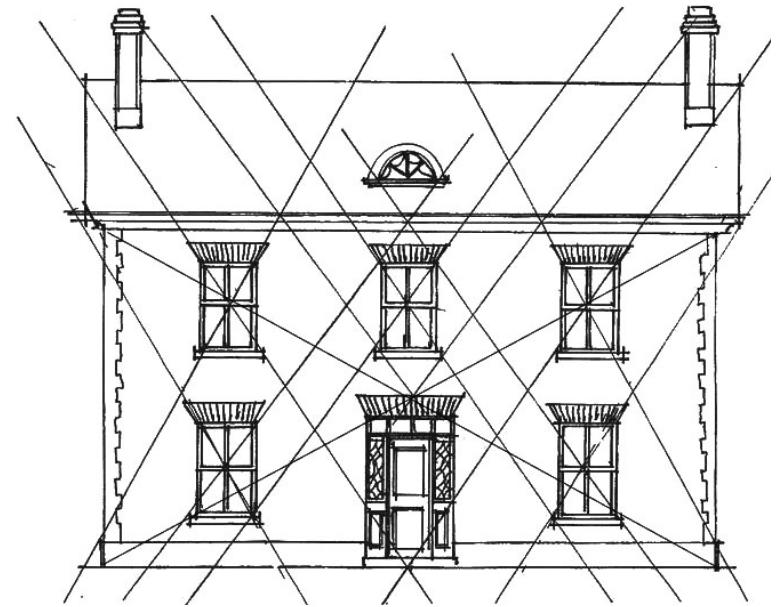

Geometry governed most heritage design. In this example, from Black Creek Pioneer Village, the diagonals of the window openings relate to significant elements in the elevation and to each other. The diagonals of the main wall relate to the windows and front-door keystone, as well.

If a building is pleasing to the eye, it is probably rich in such relationships.

Drawing by Steven Bell.

9.2 Heritage Design and Details

9.2.2 Composition Cont'd

The proportion of windows to walls and the proportions of individual window openings and window panes are an important aspect of composition.

Traditionally, windows are between 15 and 20 percent of a wall, and windows are taller than they are wide, usually with a ratio of 2:1 or more. In most heritage styles, individual window panes are also taller than they are wide.

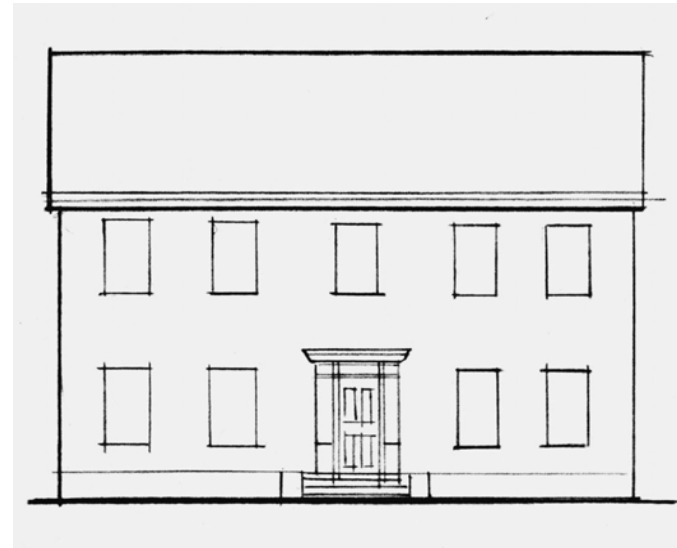

Appropriate: 15 to 20% opening is historically correct.

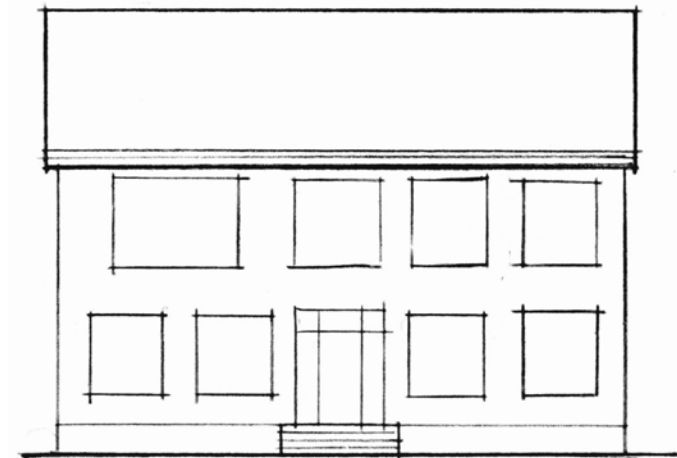

Inappropriate: 30 to 40% is excessive.

9.2 Heritage Design and Details

9.2.3 Entrances and Doors

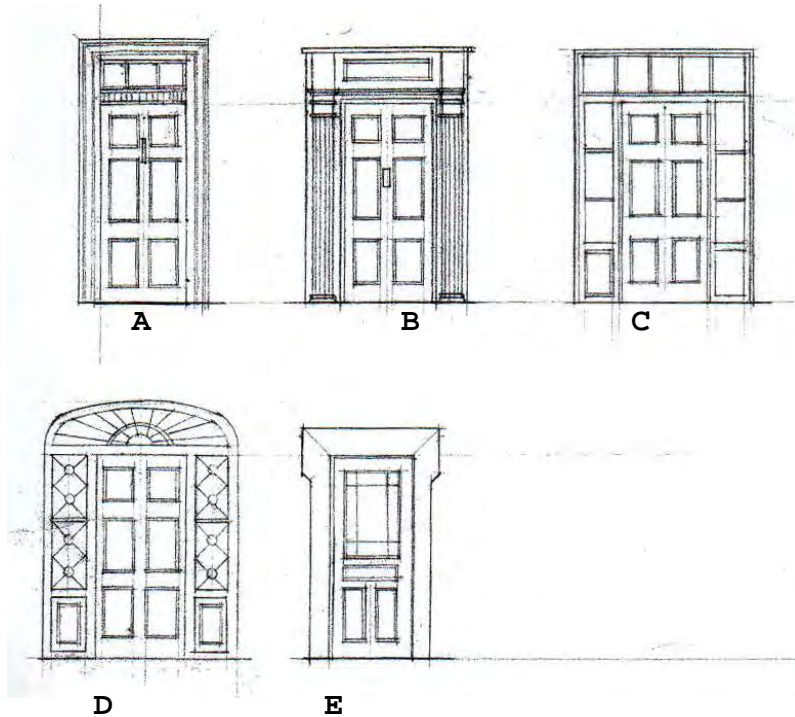

Entrances in heritage buildings are usually provided with some elaboration. In the simplest Georgian cottages this might only consist of fluted casings and a simple cornice, but a plain transom above the door was common.

Later styles made use of sidelights as well, which always had solid panels below the glazing.

The proportional scheme of the building governed the design, so that even ornate entrances did not overwhelm the building.

Entrance doors were not glazed until the Victorian era.

- A. Solid panel door with transom and wood casing.
- B. Solid panel door with classical cornice.
- C. Solid panel door with transom and sidelights.
- D. Solid panel door with decorative sidelights and fanlight transom.
- E. Wood panel door with decorative glazing and eared casing.

9.2 Heritage Design and Details

9.2.3 Entrances and Doors Cont'd

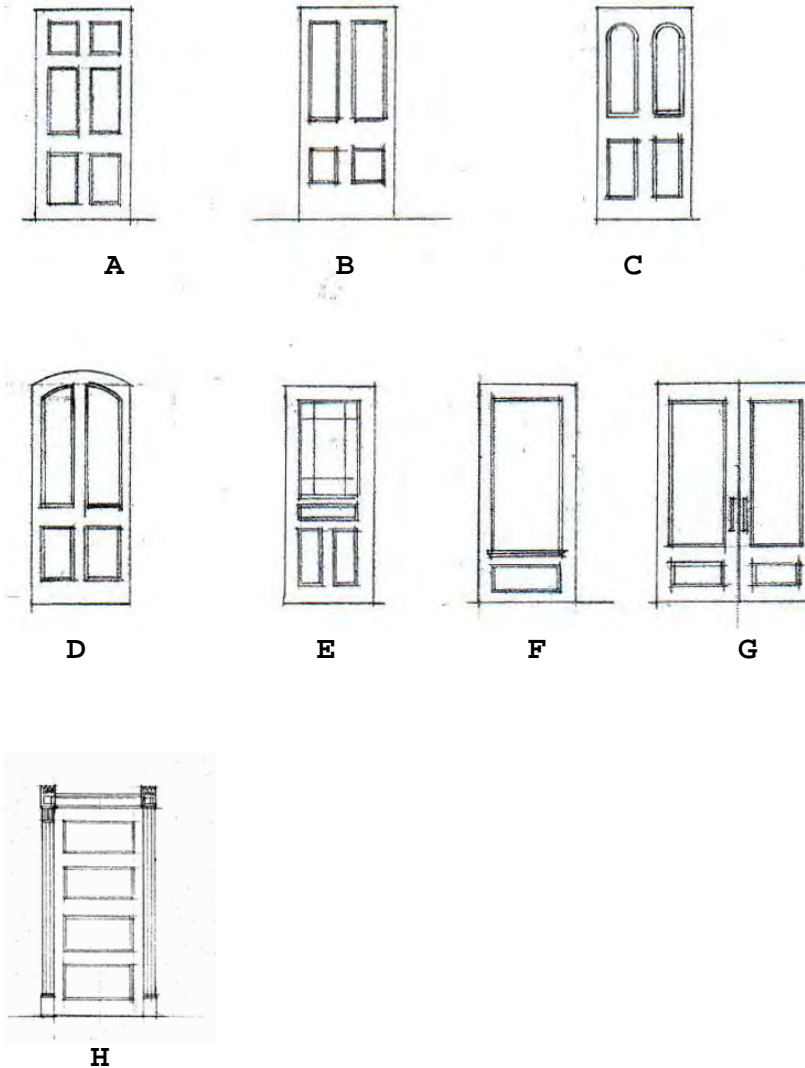

Log-cabin pioneers built simple plank doors, such as you would find on a barn, but as soon as skilled workers became available, doors were built in frame-and-panel construction.

Georgian doors tended to have 6 panels. The example shown at the top left is called a 'Cross and Bible' door, because the rails between the top four panels form a cross, and the two panels below are said to be an open book.

Later styles used 4-panel doors, with very tall top panels. These provide a vertical emphasis, in keeping with the Gothic Revival, Victorian Vernacular, and Italianate styles.

In the late 19th and early 20th centuries, the horizontal emphasis of Edwardian and Arts and Crafts styles led to doors with horizontal "ladder" panelling.

When large pieces of glass became available, around 1850, doors began to be glazed. In the simplest case, the two upper panels of a 4-panel door would receive glass, but the ability to glaze the full width of a door led to a variety of panel designs.

- A. Cross and Bible Door
- B. Four Panel Door
- C. Arched Panel Four Panel Door
- D. Arched-head Four Panel Door.
- E. Glazed Wood Panel Door.
- F. Glazed Wood Shopfront Door.
- G. Paired Glazed Wood Shopfront Door.
- H. Four Panel "Ladder" Door

9.2 Heritage Design and Details

9.2.4 Windows and Shutters

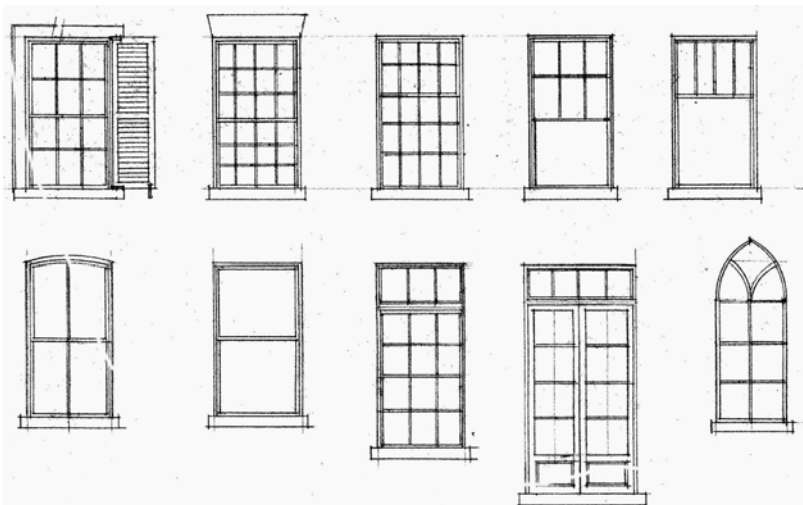

Most heritage styles used double-hung windows. These are described by the number of panes, or lights, in each sash. If there are 6 panes above and 6 below, it's called a 6 over 6, or 6/6 window.

Before around 1850 the size of available panes was small, and the number of lights was large. Typical Georgian window were 12/12. As glass technology improved, larger glass led to 2/2 and then 1/1 windows.

Later styles, such as Edwardian and Arts and Crafts, made use of both large and small lights, and 6/1 and 8/1 windows became common.

As a general rule, windows had more height than width, and the individual lights shared that vertical proportion. Glass that is wider than it is high is found only in very wide single light sash.

Casement windows appeared in only a few styles. Some Regency windows could be called casements, though they are more like French doors, with sills barely above the floor. The Craftsman style was the first to use what we would call casements today.

Shutters were provided to secure windows from storms and damage, and they were designed and installed to close the window opening. They are hinged at the window jamb, and each shutter covers exactly half of the opening. Usually they were louvered.

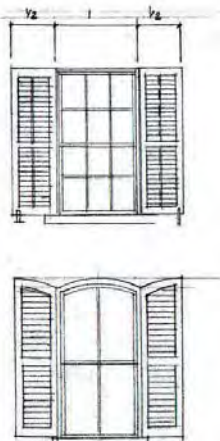

9.2 Heritage Design and Details

9.2.5 Bay Windows

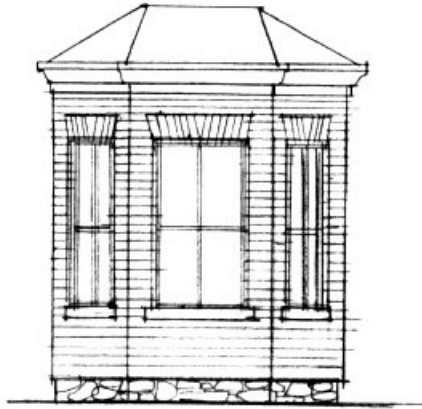

Victorian

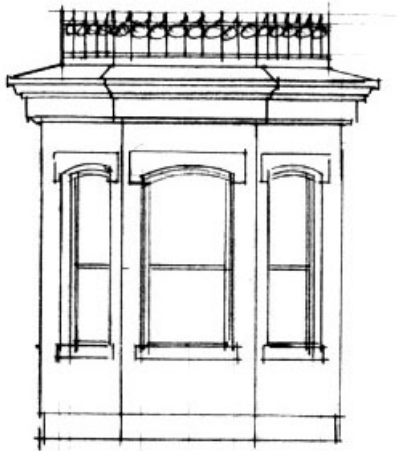

Victorian, Italianate,
Second Empire

Bay Windows provide visual interest on the exterior and create a well-lighted nook on the interior. They appear on a number of historic styles, but not all. There is a tendency to overuse them in new buildings, when they are not appropriate to the overall architectural style. Care should also be taken to use window shapes and glazing patterns suitable to the overall architectural style.

Most bay windows in most styles are angled, usually at 45 degrees, but the Arts and Crafts style, and some Victorian Vernacular buildings used square bays.

In Maple, most bay windows are on the ground floor only, and extend to the ground. Some Arts and Crafts houses have square bay windows that don't extend to the ground, as seen at 18 Richmond Street. A protruding bay high on a wall is called an oriel window.

9.2 Heritage Design and Details

9.2.6 Gable Ends



Classical Styles



Victorian Gothic



Queen Anne Revival
Gable Peak

The classically-based styles, such as Georgian and Classical Revival used fairly plain bargeboards. A plain board, with perhaps a small ogee moulding on the upper edge, was the most common design. The eaves would include a wooden gutter in the shape of a wide ogee-moulding. This shape was later replicated by sheet-metal eaves-troughs. Below this was usually a fascia board, sometimes with additional moulding at the top, or perhaps dentils. The fascia and mouldings typically turned the corner at the gable end as shown in the upper sketch, in what is called an eaves return.

The Victorian Gothic styles used elaborate bargeboards in a wide variety of forms—what has come to be called “gingerbread”. Sometimes these were sinuous shapes cut out on a scroll saw. In other cases pierced patterns were cut into a simpler board. A common feature was a finial at the peak, as shown in the middle sketch. There are often characteristic local styles in Victorian trim, and although Maple has some fine and elaborate gingerbread, historic photographs suggest that many houses had simple bargeboards, and used trim more freely at porch columns, and under porch eaves.

It is good practice to repair or replace historic gingerbread in the original pattern, using accurate dimensions. Historic drawings or photographs, or nearby local examples can be used as sources for an authentic design.

The Queen Anne Revival style tended to use built-up detail, with square panels and round medallions applied to a plain bargeboard. The peak of a gable was often given an ornate decoration of built-up work, as shown in the lower sketch.

9.2 Heritage Design and Details

9.2.7 Dormers

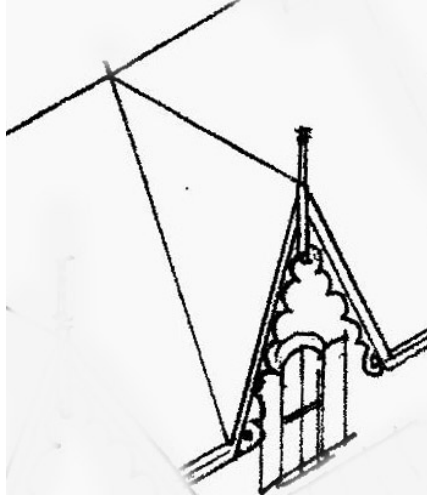

Victorian Gothic

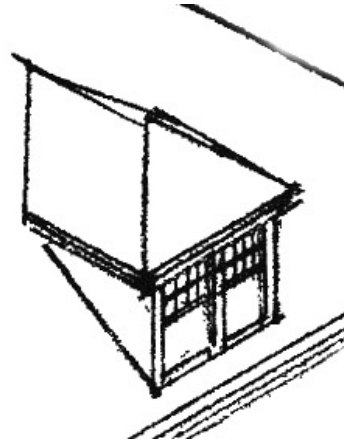

Edwardian.
Foursquare is similar, but uses simple
1 over 1 glazing

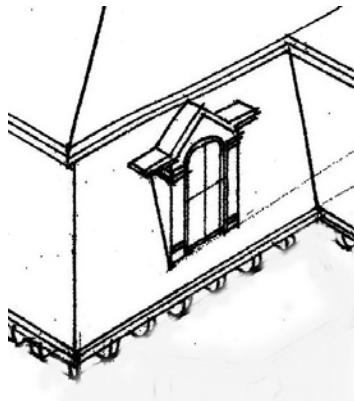

Second Empire

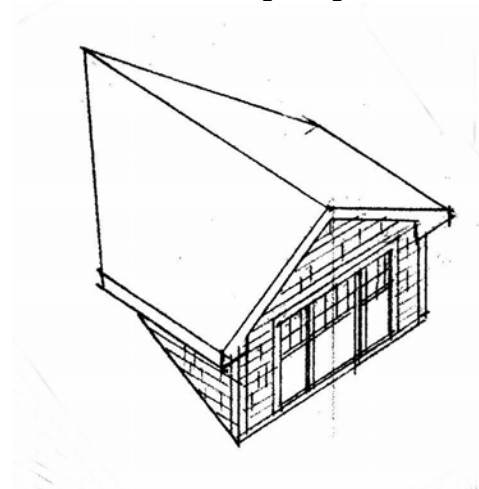

Arts and Crafts/California Bungalow

Dormers provide useful light in attic spaces, and as described in Section 9.1, the use of an attic avoided the higher taxes on a two-storey house in the early 19th Century.

Victorian Gothic dormers rise from the main wall of the house, and are not set back from the roof. When the bargeboard meets the main eaves they are usually considered gables rather than dormers.

In Maple, roof dormers appear on the Second Empire, Edwardian, Foursquare, Arts and Crafts, California Bungalow Styles. When designing new dormers, care should be taken that they are appropriate to the architectural style in all details: roof slopes, fascias, soffits, window shapes and glazing.

9.2 Heritage Design and Details

9.2.8 Porch Design

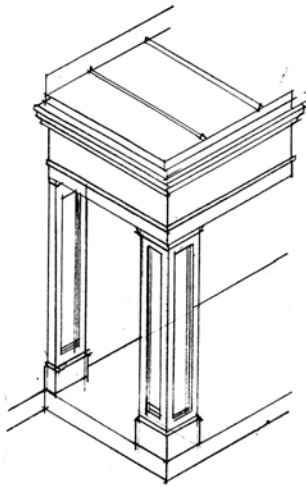

Georgian

Wood columns, round or square classical design.

Columns may be plain or fluted.

Flat metal roof or front-facing pediment.

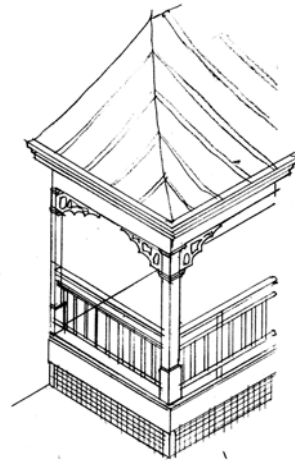

Victorian Gothic

Wood columns, often turned.

Ornate “gingerbread” brackets.

Often with metal roof, often “bell-cast” shape.

Balusters on railing usually square.

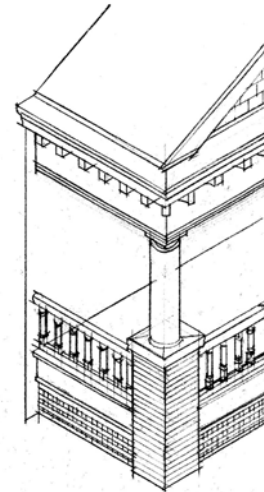

Edwardian Styles

Classical columns on stone-capped brick piers.

Front-facing pediment or hipped shingle roof.

Classical detailing like column capitals and dentils.

Balusters on railing turned or bellied.

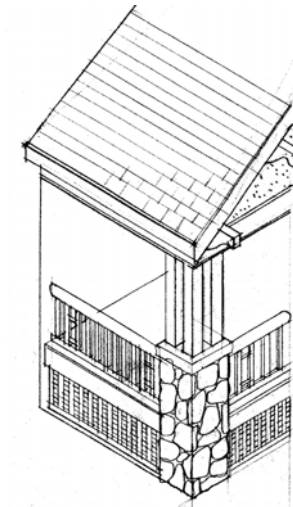

Arts and Crafts

Rustic timber columns, often clustered, often on rubble base.

Sense of exposed carpentry, with exposed joist tails, often cut to form a bracket.

Balusters often installed with thin face outward, often bunched in groups of 2 or 3.

9.2 Heritage Design and Details

9.2.9 Brickwork

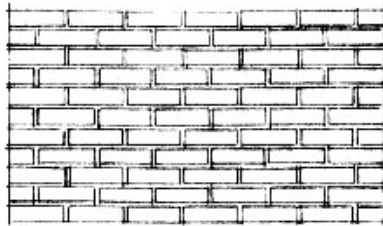

Running Bond

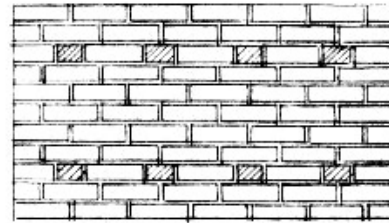

Common Bond

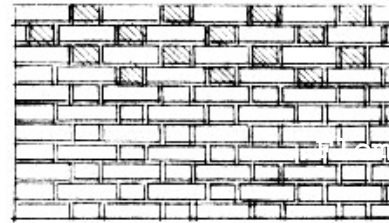

Flemish Bond

Historic brick walls were solid masonry, and in order to carry the weight of floors and roofs they were two or more bricks thick. It was structurally necessary to tie the inner and outer wythes together, and the simplest and surest way to do this was to put headers across the thickness of the wall at some regular interval. The pattern in which the bricks are laid is called the “bond”.

Modern brickwork is usually a veneer in front of a frame or concrete block structural wall. The veneer is typically tied to the structure with metal ties, and there is no structural need for headers. Because it's quick and easy, the running bond, shown at upper left, is commonly used for modern brick veneer walls.

Historic bonds, which use headers, provide a subtle but lively texture to a wall. The cost of laying one of the historic bonds by using half-bricks to replicate the headers is extremely small, and it is a simple way to maintain heritage character in new construction.

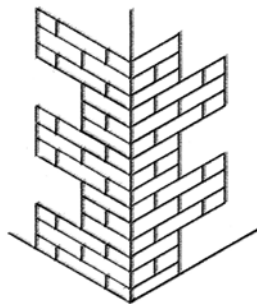

Correct Quoining

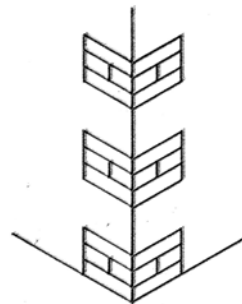

Incorrect Quoining

Brick quoins imitate larger stone quoins, which interlock to strengthen the corner of a building. A quoin block has a short side and a long side, and brick quoins should be laid in the same form, as shown in the sketch on the left. The sketch on the right shows what not to do.

9.2 Heritage Design and Details

9.2.9 Brickwork Cont'd

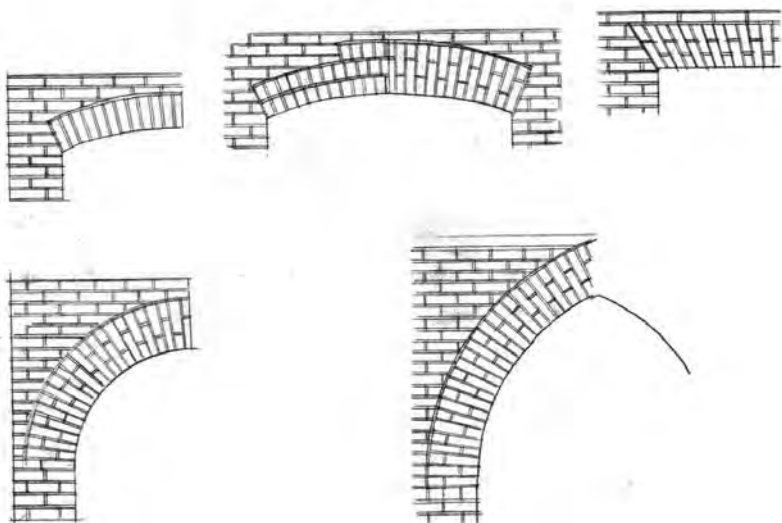

Before the use of iron and steel in construction, lintels over structural openings in brick walls were either solid stone or brick arches. Modern construction commonly uses steel lintels, hidden by the brickwork. To create an authentic appearance, the bricks should be laid to replicate historic structural arches. It is common practice to use a simple soldier course above an opening, without the outward slant that provides arch action in an authentic arch.

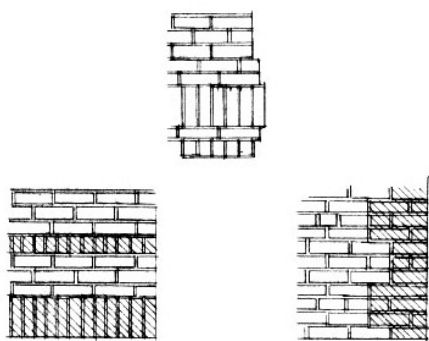

Victorian and Queen Anne Revival brickwork was rich in colour and pattern. Projecting and recessed courses, the use of headers, rowlock, and dogtooth courses, and contrasting quoins were all used to enliven masonry. It's not unusual to find designers limiting themselves to quoins and soldier courses. However, when working in the vocabulary of historic styles, it is more authentic to make use of the full variety of historic brickwork. Some manufacturers provide shaped bricks, which were also part of many historic styles.

9.2 Heritage Design and Details

9.2.10 Wood Siding

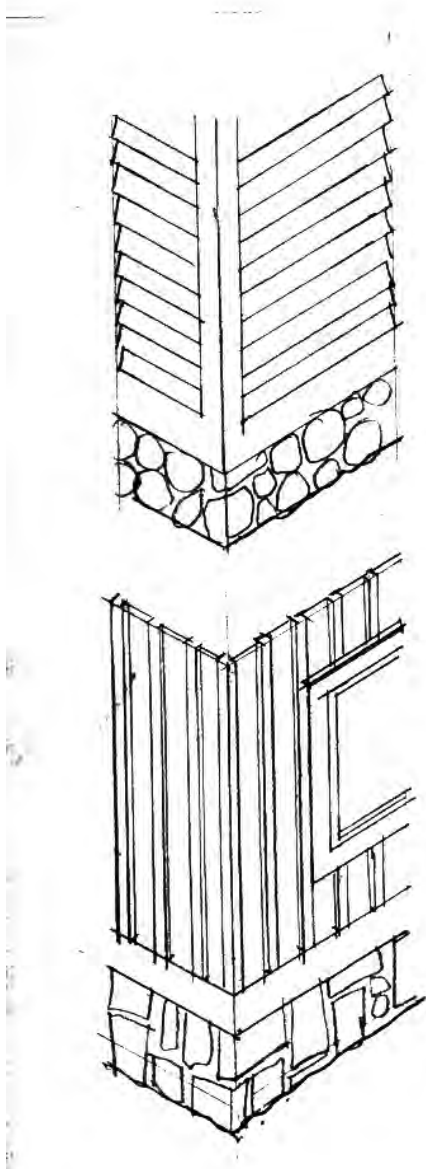

The most typical historic wood siding types were clapboard and board and batten. Clapboard was commonly installed with about 4 inches to the weather.

Board and batten siding was typically about a 10 inch board with a 2 inch batten.

Note the wide skirt board at the bottom of the walls, and the corner boards on the clapboard.

Stone foundations were common in 19th century buildings. The top sketch shows split-faced fieldstone, and the bottom sketch shows dressed fieldstone

9.2 Heritage Design and Details

9.2.11 Fencing

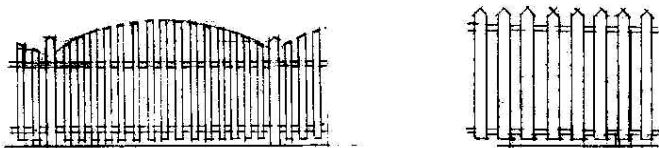

Traditional front-yard fencing is usually fairly low. Historic photographs show a wide variety of fence types in old Maple, including split-rails, horizontal boards and most commonly, wood picket fences.

There is, and was, considerably variety in design. Narrow boards and wide boards; square, pointed, and rounded tops; and railing-type fences with the pickets housed in the top and bottom rails are all in evidence

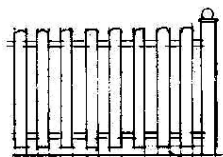
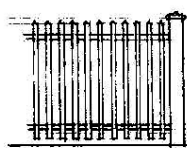

Iron fences appeared on wealthier properties in the late Victorian age, but they don't appear in any of the historic photographs of Maple.

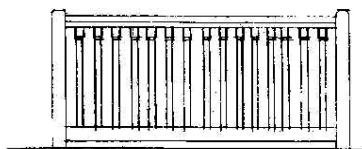

A very substantial picket fence is seen in front of the James Kirby House at 9983 Keele Street. Photo from the Vaughan Archives

9.3 Existing Heritage Buildings

9.3.1 Overview

Maple is fortunate in having numerous historic buildings, most of which are structurally sound, with original architectural details largely intact in many cases. In many cases, details are in need of maintenance or repair, or have been obscured or removed in previous renovations. This section aims to assist in the preservation of historic architecture, and the restoration of lost or concealed heritage character, through design that follows the original or is at least sympathetic to it, when new work is undertaken.

Guidelines:

- The existing heritage structures are the most significant elements of the heritage character of Maple.
- The map to the left shows the buildings that are considered to be heritage properties for the purposes of this Plan. There are 51 properties in the District that are listed in the Vaughan Register of Property of Cultural Heritage Value. The consultants have identified 4 additional properties: 9690, 9706, and 9964 Keele Street, and 9 Hill Street.
- Proper maintenance of heritage structures prevents deterioration, and is the most cost-effective means of preserving heritage character.
- When heritage features are damaged or deteriorated, repair and restoration are preferable to replacement.
- New construction should not damage or conceal heritage features.
- New construction should include restoration of heritage features that have been lost or concealed by previous renovations.

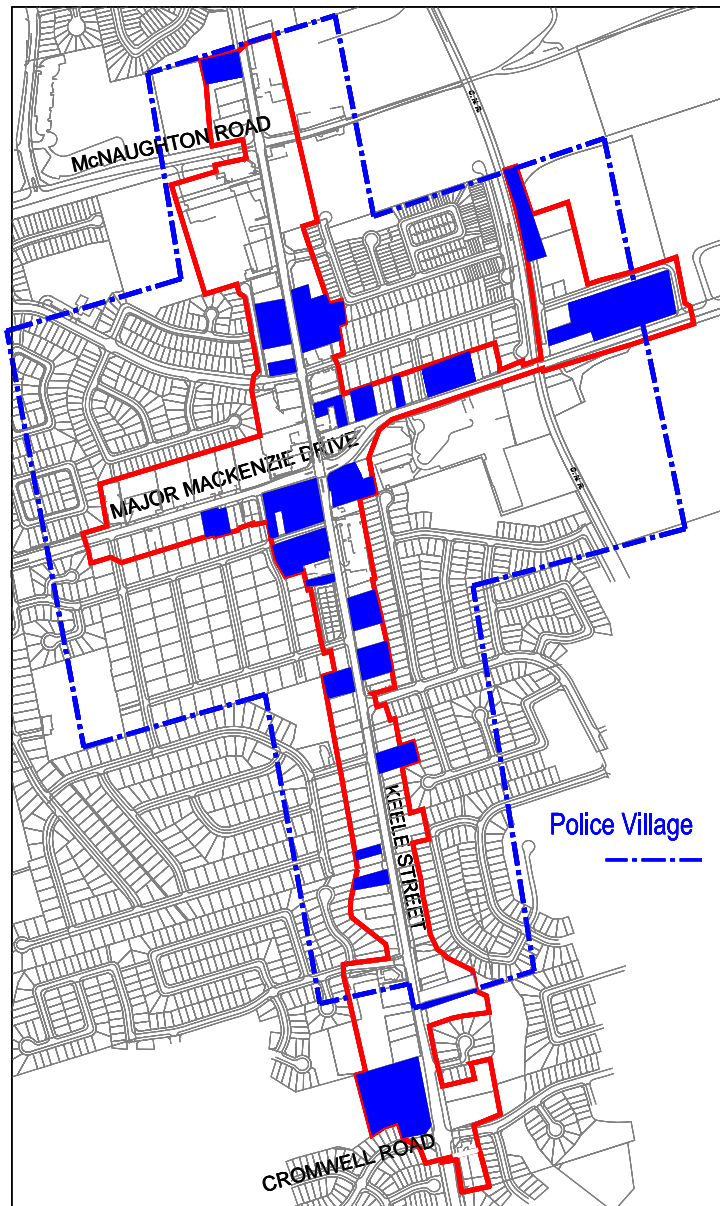

9.3 Existing Heritage Buildings

9.3.2 Historical and Technical Research

The original state of existing heritage buildings should be researched before work is undertaken. On-site investigation often reveals original details concealed under later work. The Vaughan Archives has an extensive collection of historic photographs.

Maintenance, repair, replacement and restoration work should be undertaken using proper heritage methods. Modern materials and methods of construction can have detrimental effects on old construction if proper methods are not used. This is particularly true of old brick. Section 10 lists some books containing relevant technical information.

The United States National Parks Service publishes *Preservation Briefs*, with detailed 'how-to' information on many aspects of heritage preservation and restoration. All 42 of these publications can be downloaded from: www.cr.nps.gov/hps/tps/briefs/presbhom.htm

The Parks Canada Standards and Guidelines for the Conservation of Historic Places in Canada is similar, and is available on line at: www.pc.gc.ca/docs/pc/guide/nldclpc-sqchpc/index_E.asp

The Ontario Ministry of Culture also has 13 *Architectural Conservation Notes* at: www.culture.gov.on.ca/english/culdiv/heritage/connotes

9.3.3 Recording Original Construction

It is important to build up the record of historic construction in the District. No reconstruction or removal of historic architectural detail should be undertaken without recording the original with drawings and/or photographs. Copies of these records should be given to Cultural Services at the City of Vaughan. Building such an archive of information is an important community effort.

9.3 Existing Heritage Buildings

9.3.4 Building Maintenance



The principal enemies of existing heritage buildings are fire and water. Proper maintenance is the best way to prevent damage and deterioration from these causes. **The loss of heritage detail and even entire buildings, due to simple neglect, is an avoidable tragedy.**

Standard fire-prevention practices should be followed: check electrical systems, and don't overload circuits; ensure that heating systems are in good condition; store combustibles properly.

Roofing, flashing, and rainwater drainage should be maintained in good condition. It is far better and cheaper to keep moisture out of the building, than to deal with the damage later.

Structural damage that admits moisture, such as settlement cracks, should be promptly repaired.

Painted woodwork should be maintained.

9.3 Existing Heritage Buildings

9.3.4.1 Masonry Cleaning

Masonry cleaning should be done in a non-destructive manner. Ontario bricks are soft and subject to deterioration by harsh cleaning methods. Good results can usually be obtained with detergents and water and a stiff natural-bristle brush. Some professional water-borne chemical agents are acceptable. Sand-blasting and high-pressure water blasting are unacceptable.

Historical photographs show that most original masonry in Maple was unpainted. Unless paint can be historically documented it should not be applied, and existing paint should be removed. Paint may be applied only where deterioration of the masonry leaves no other choice. Paint must be vapour-permeable (breathing-type) to prevent deterioration. See illustration at right.

Preservation Briefs has full information on proper materials and methods. See Section 9.3.2 for website.

Guidelines:

- Clean masonry using detergents and a stiff natural bristle brush. If this doesn't produce satisfactory cleaning, use only professional water-borne chemical agents for further cleaning.
- Do not use sand-blasting or high pressure-water for masonry cleaning.
- Do not paint historic masonry unless deterioration of masonry leaves no other choice.
- If masonry must be painted, use an appropriate breathing-type paint.
- Do not cover historic masonry with other materials such as stucco.



Non-breathing paint on brick. The vapour pressure of moisture in the brick blisters the paint, when it is able. If the paint adheres strongly, the pressure causes the brick surface to spall off, along with the paint, as seen in the centre of the picture. This lets in even more moisture, and the problem grows.

9.3 Existing Heritage Buildings

9.3.4.2 Masonry Repointing

Historic lime mortars weather back from the wall face over time, particularly when they are subject to moisture. This is normal, and repointing is only necessary when the mortar is deeply eroded. Repointing should only be undertaken in areas where the mortar has deteriorated. Don't remove sound mortar unnecessarily, but do poke and prod to make sure the mortar you are keeping is sound. If the pointing mortar is correctly formulated, and the joint is tooled to match the original, the repointing will not present a "patchy" appearance.

Historic lime mortar is softer and more water-permeable than modern portland cement mortars, and it preserves the brick by absorbing movements and providing a path for water to leave the wall. Modern Portland cement mortars, are designed for modern hard-fired bricks, and are highly destructive to softer historic bricks. The colour of historic mortars comes primarily from the colour of the sand in the mix, so care is required to establish a matching appearance.

Guidelines:

- Repair structural damage before repointing. Structural cracks may be letting in the moisture that is eroding the mortar.
- Do not use power tools to remove old mortar. They can damage the weather-resistant skin of the brick and cause future deterioration of the wall.
- Use lime mortar for repairs and repointing of historic brick. Match the original in formulation, with a cement content no greater than one-twelfth of the dry volume of the mix; the cement must be white portland cement and not grey.
- Do not treat historic brick with silicones or consolidants. They trap water vapour behind the surface of the brick which may damage the face by freezing or leaching of salts.



Progressive deterioration: Rainwater splashing on the porch and steps eroded the mortar. That let increasing amounts of water into the bricks and mortar below, and they are spalling and washing away, letting in even more moisture.

9.3 Existing Heritage Buildings

9.3.4.3 Painting Woodwork



Properly maintained and protected woodwork is a very durable building material. Deterioration of wood is almost always due to moisture problems: either a failure of the paint film or a problem, such as a flashing or roofing failure, that allows moisture to infiltrate from above and behind the finish surface. Blistering or peeling paint is usually a sign of moisture penetration. The source of the moisture should be identified and corrected before repainting. Refer to Section 9.3.4.5, below, if repairs are necessary before repainting.

Normally, it isn't necessary to remove sound, well-bonded paint before repainting. Paint removal, when required, is best done using gentle traditional methods. Chemical strippers can impregnate wood and harm the bonding ability of new paint, and excessive heat can cause scorching damage.

Guidelines:

- Inspect existing paint. Blisters or peeling paint usually mean water is getting into the wood, and the source of water should be corrected.
- Don't "strip" woodwork, unless paint build-up is excessive and obscures architectural detail. Just remove loose paint and feather edges.
- Don't use chemical strippers or torches to remove paint. These damage the wood and cause future problems.
- Use suitable heritage paint colours. Original paint colours can usually be found by sanding or scraping through overpainted layers. Otherwise, approved heritage palettes are available at Cultural Services.
- Both *Preservation Briefs* and *Architectural Conservation Notes* have information on painting. See Section 9.3.2. for websites.



9.3 Existing Heritage Buildings

9.3.5 Repair and Restoration

Repair and restoration should be based on proper heritage research, and be undertaken using proper heritage materials and methods. Section 10 lists helpful sources of information.

9.3.5.1 Brickwork

Brick repair should be undertaken using proper heritage materials and methods. If available, salvaged bricks matching the original should be used for replacement material. If new bricks are necessary, they should match the original in size, colour, and finish. The traditional Ontario brick size is still manufactured, but in small quantities, so material may have to be ordered well in advance of the work.

Historic bricks require the use of historic lime mortar. See the notes and guidelines in Section 9.3.3.3, under masonry repointing.

Guidelines:

- Repair structural damage before restoration.
- Use matching bricks for repairs, either salvaged old material or the best modern match in size and colour.

9.3.5.2 Stonework

Spalled stone can be restored using professional epoxy-based fillers matching the underlying stone. More serious deterioration will require replacement by new material, matching the existing. Use of precast concrete to replace stone is discouraged.

9.3 Existing Heritage Buildings

9.3.5.3 Roofing

Heritage buildings might have originally had wood shingles, slates, or sheet metal roofing. Very few of the original roofs remain, and the asphalt shingle is the dominant roofing material in Maple today. In re-roofing heritage buildings, care should be taken to choose a material that relates to the original roofing. If asphalt shingles are selected, colours should be black or a dark grey, like slate or weathered cedar. The use of textured premium grades improves the simulation, and synthetic slates and panelized synthetic cedar shingles can present a very realistic appearance. Note that roofing tiles are not part of the local vernacular, and tile or simulated tile (of concrete or pressed steel) are not appropriate.

9.3.5.4 Wood Frame Construction

The earliest buildings were of log construction but were quickly supplanted by wood frame construction. Over history, original siding materials would have included wood clapboard, board and batten, and more rarely, stucco. Agricultural buildings used vertical boards. The heritage quality of many old buildings has suffered by the application of aluminium or other modern sidings. Renovations to wood frame heritage construction should include restoration of original siding materials when they have been covered by these inappropriate materials.

9.3.5.5 Decorative Woodwork

Deteriorated woodwork should be repaired, if possible, rather than replaced. Repairs should use the same wood species and design as the original. If replacement is necessary, it should conform to the original design, and wood should normally be used, rather than modern materials. Well-maintained and properly detailed woodwork is quite durable: much of the existing heritage decoration in Maple has lasted more than a century. In certain situations, with extreme exposure to weathering, modern materials may be considered acceptable substitutes.



With occasional maintenance, the wood “gingerbread” trim and windows have lasted about 130 years.

9.3 Existing Heritage Buildings

9.5.4.6 Windows Repair and Restoration

Original window frames and sashes should be repaired if possible, rather than replaced. Repairs should be limited to damaged portions of the window assembly. This is not only good heritage practice: it is usually less costly. Repair material should be of the same species and profile as the originals.

Historic wood windows perform very well in terms of life-cycle costing, and can have very good energy efficiency as well. It is worth considering these factors before deciding to replace original windows. Many historic windows have lasted for more than a century, with only minor routine maintenance, such as puttying, painting, and the occasional adjustment of fit and hardware. It is unlikely that any modern replacements would venture to guarantee similar longevity.

Energy costs need to be considered as a whole, not simply comparing the R-values of the glazing. Heritage buildings have a relatively small percentage of openings compared with more modern designs. Even an ordinary wall outperforms the best glazing by a large margin.

In addition, the energy performance of a window assembly is more dependent on air leakage than on the insulative qualities of the glass itself. It is fairly easy and inexpensive to improve the fit and add weatherstripping to historic windows, so that air infiltration matches modern standards. The addition of interior or exterior storm windows gives further energy savings, and eliminates or reduces the biggest problem of single glazing, which is cold-weather condensation.

A recent speech by Donovan D. Rypkema, the foremost expert in the economics of preservation, noted that:

Properly repaired historic windows have an R factor nearly indistinguishable from new, so-called “weatherized” windows.

Regardless of the manufacturers’ “lifetime warranties,” 30 percent of the windows being replaced each year are less than 10 years old.

One Indiana study showed that the payback period through energy savings by replacing historic wood windows is 400 years.¹

A full discussion of energy considerations in historic buildings is available in Preservation Briefs No. 3. See Section 9.3.2 for the website.



Life-cycle costing makes wood look good. The District has many wood windows that are still in service after more than a century.

“No maintenance” materials can’t be maintained, and need replacement when they fade, chip and dent.

¹ Speech to the Annual Conference of the National Trust for Historic Preservation. Portland, Oregon, October 1, 2005.

9.3 Existing Heritage Buildings

9.3.5.6 Windows Replacement Windows

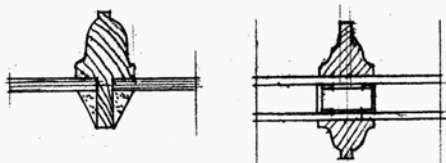

The proportions of original glazing bars can be matched for double-glazed windows with bonded muntins with internal spacer bars.

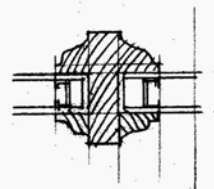

Most double glazed “true” lights require glazing bars that are much wider than the originals.

If original windows cannot be repaired or restored, replacement windows are an option. If possible, replace only damaged portions; for example, replace the sash but retain the frame. Window design should match the original in type, glazing pattern, and detail. In many buildings, windows have been replaced, and it may require some research to determine the original design. The descriptions in Section 9.2.3 may be useful, or original windows in similar neighbouring buildings might offer a clue.

In recent years window manufacturers have responded to the market for authentic heritage windows. Catalogues now include round- and segmental-arch heads and a variety of glazing patterns, providing good representations of most historic styles.

Some care needs to be taken in detailing. Two common problems are heavy glazing bars, and horizontal orientation of the panes in multi-light sash.

True muntins for double-glazed windows are too heavy to preserve the proportions of original windows. Bonded muntins inside and out, with spacer bars in the air space, provide better proportions for an authentic appearance in most residential-scale windows.

Care is also needed in the proportions of the “panes”, which should have a greater height than width. Depending on the manufacturer, and the size and type of window, the manufactured muntin grilles may not have correct proportions.

“Snap-in” interior muntins or tape simulations are not acceptable.

Casement windows that mimic single-hung windows are also not acceptable.

9.3 Existing Heritage Buildings

9.3.6 Renovations

When a renovation on a heritage building is undertaken later work that conceals the original design or is unsympathetic to it should be removed.

Guidelines:

Incorporate restoration of original work in exterior renovation projects.

- Use authentic original materials and methods. For example, when replacing aluminum siding, use wood siding or board and batten.
- Replace missing or broken elements, such as gingerbread, spindles, or door and window trims.
- Remove items, such as metal fascia and soffits that conceal original architectural detail.

9.3 Existing Heritage Buildings

9.3.7 New Additions to Heritage Buildings

Architectural Style

New attached additions to heritage buildings should be designed to complement the design of the original building.

Guidelines:

- Design additions to maintain the original architectural style of the building. See Section 9.1.
- Use authentic detail. See Section 9.2.
- Research the architectural style of the original building. See Section 10 for useful research sources.
- Follow the relevant guidelines for new construction in Section 9.5.



These additions follow the Georgian precedent of the original building.

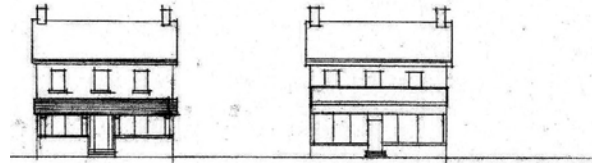
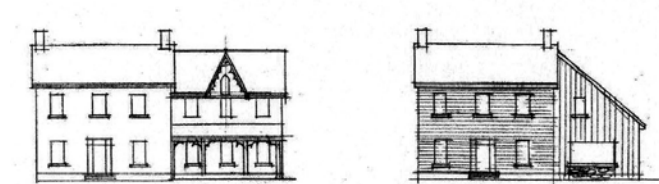

These additions use styles that don't match the original.

9.3 Existing Heritage Buildings

9.3.7 New Additions to Heritage Buildings Scale

New additions to heritage buildings should respect the scale of the original building.

Guidelines:

- Don't design additions to a greater height or scale than the original building.
- Don't design additions to predominate over the original building.

Usually, additions should be located at the rear of the original building or, if located to the side, be set back from the street frontage of the original building.

- For garage additions, see Section 9.3.8
- Use appropriate materials. See Section 9.8.
- Avoid destruction of existing mature trees. See Section 9.7.

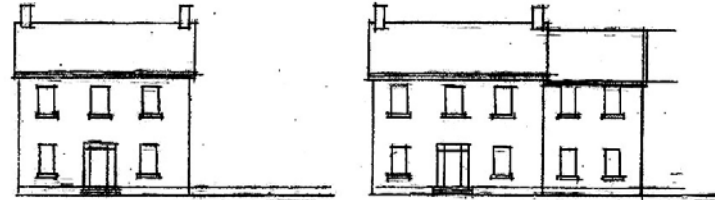

In keeping with good heritage practice, these additions are of lesser scale than the original house and are set back from the main front wall.

9.3 Existing Heritage Buildings

9.3.8 Outbuildings for Heritage Buildings.

Traditionally, garages or stables were built as separate rear outbuildings with gable roofs.

Guidelines:

- Work on existing heritage outbuildings should retain or restore original design features.
- New garages should respect traditional siting as separate rear outbuildings, if possible.
- Connected garages should minimize their street presence. For example, a garage may be turned so that the doors face a side lot line, or it may be set well back from the main frontage, with the connection to the main building disguised or hidden.
- Design garages to traditional outbuilding forms, with gable roofs, and frame or brick construction.
- Use single-bay garage doors, compatible with traditional designs. Suitably designed overhead doors are now widely available.
- Other outbuildings, such as garden and storage sheds, should be of traditional wood construction when visible from the street. Prefabricated metal sheds, if used, should be located to be out of view from the street.

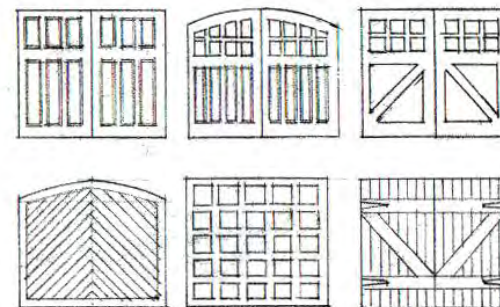

Garages should be designed with single bays, and doors should reflect historic designs. There are now a wide range of heritage-compatible doors available from many manufacturers.

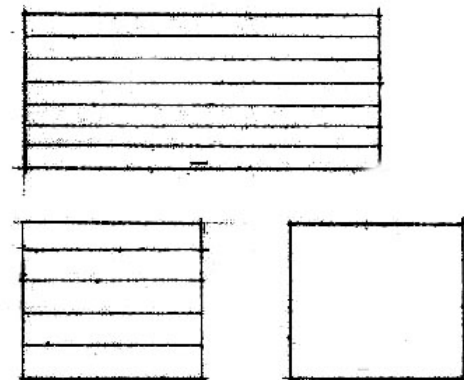

Double-bay garage doors and flat slab-type garage doors are not appropriate in the District

9.4 Existing Non-Heritage Buildings

9.4 Existing Non-Heritage Buildings

Most of the buildings in the Village are not considered heritage structures. Many of these, by virtue of their scale, siting, and surrounding landscaping, nevertheless contribute to the overall character of the area. Buildings deserve some respect on their own terms, and it is not the intent of the Guidelines to ask newer buildings to pretend to be anything other than what they are.

9.4.1 Design Approaches

Additions and alterations to non-heritage buildings have an impact on their heritage neighbours and the overall streetscape. There are two design approaches that are appropriate to additions and alterations to such work in the Village.

9.4.1.1 Contemporary Alteration Approach

Ordinarily, a modern building should be altered in a way that respects and complements its original design. Interest in preservation of the modern architectural heritage is growing, and good modern design deserves the same respect as good design of the 19th century.

Guidelines:

- Additions and alterations using the Contemporary Alteration approach should respect, and be consistent with, the original design of the building.
- The Guidelines in Section 9.3.6 for additions to heritage buildings apply, in terms of siting, scale and location of additions.
- Many modern buildings are old enough to have already undergone renovations, which may not be in character with either the original design, or historic precedent. In such cases, the design of further new work should restore the architectural consistency of the whole.
- In some cases, modern buildings predominantly feature materials that are out of keeping with the local vernacular heritage, such as tile or artificial stone veneer, and tile or simulated tile roofing. Replacement of these materials with more sympathetic ones, when renovations are being undertaken, is encouraged.

A typical 1970s ranch bungalow.

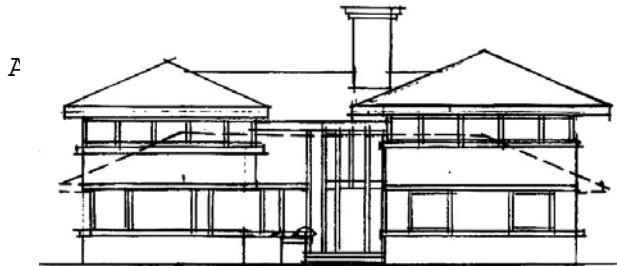
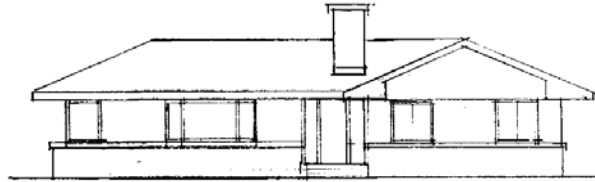

The Contemporary Alteration approach used in putting on a second storey addition.

9.4 Existing Non-Heritage Buildings

9.4.1.2 Historical Conversion Approach

In some cases, a modern building may be altered in a way that gives it the appearance of an older building. A historical conversion should have the integrity of an historical architectural style. This approach means considerably more than sticking on a few pieces of historical decoration; it may require considerable new construction to achieve an appropriate appearance.



The Historical Conversion approach used in putting a second storey addition on the same house. above.

Guidelines:

- Additions and alterations using the Historical Conversion approach should rely on a local heritage style described and depicted in Section 9.1. Use of a style should be consistent in materials, scale, detail, and ornament. Refer to new construction guidelines in Section 9.5 for further guidance.
- Although most additions should be modest in comparison to the original building, the Historical Conversion approach may call for substantial additions in front of and on top of the existing building.
- Additions should avoid destruction of existing mature trees. See Section 9.7.

9.5 New Development

9.5 New Development

9.5.1 Overview

The overall heritage character of the District is composed of buildings, streetscapes, landscapes, and vistas. This overall character has more significance than any individual building, even if it is one of the finest. Within the design of any individual building, architectural elements contribute to the character of the public realm of the street. Massing, materials, scale, proportions, rhythm, composition, texture, and siting all contribute to the perception of whether or not a building fits its context. Different settings within the district have different characters of siting, landscaping and streetscaping.

New development within the District should conform to qualities established by neighbouring heritage buildings, and the overall character of the setting. Designs should reflect a suitable local heritage precedent style. Research should be conducted so that the style chosen is executed properly, with suitable proportions, decoration, and detail.

Guidelines:

- New buildings should reflect a suitable local heritage style. Use of a style should be consistent in materials, scale, detail, and ornament.
- Use Section 9.1 for preliminary guidance on styles.
- Use Section 9.2 gives further preliminary guidance on details of design and construction.
- It is highly recommended that owners engage design professionals skilled in heritage work for new buildings in the District.

9.5 New Development



9.5.2 Residential Area Overview

The residential village has a variety of lot sizes, frontages, and setbacks. Houses are mostly of a modest scale, leaving generous yards on all sides. In the historic area front yards tend to be shallow compared to the rear yards, where space was needed for stabling, herb and vegetable gardens, and orchards. An early village household needed these means for self-sufficiency, and lawns and decorative planting were minimal. The use of the yards has changed, and they provide more pleasure and less production now, but to a great extent the original village scale has persisted. Building height, lot coverage, and density are all low. The streetscapes are unified by a canopy of trees, planted in front of, behind, and beside most houses. Elements that define the heritage character of the residential village include:

- Generous lot sizes and modest house sizes, compared to historic urban development or recent suburban development;
- A variety of front-yard setbacks;
- The generous presence of mature trees, in addition to decorative shrubbery, in the front, side, and rear yards.

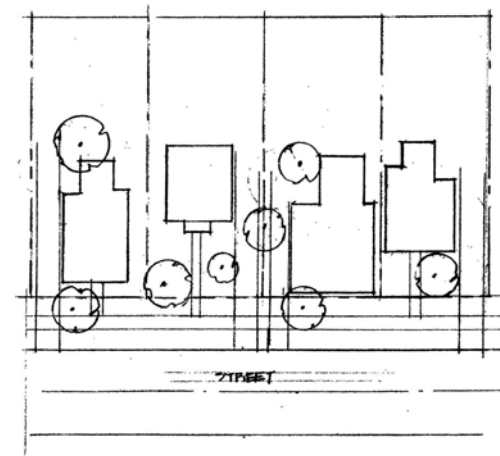

Buildings and trees share in forming the streetscape.

9.5 New Development

9.5.2 Residential Village

9.5.2.1 Site Planning

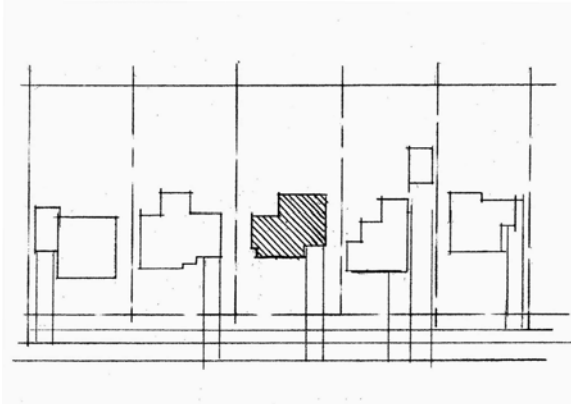

Respect the existing site plan character of similar, but not identical front-yard setbacks. Place a new building to mediate between setbacks of neighbouring buildings.

Guidelines:

- Site new houses to provide setbacks and frontages that are consistent with the variety of the village pattern.
- Site new houses to preserve existing mature trees. See Section 9.7.

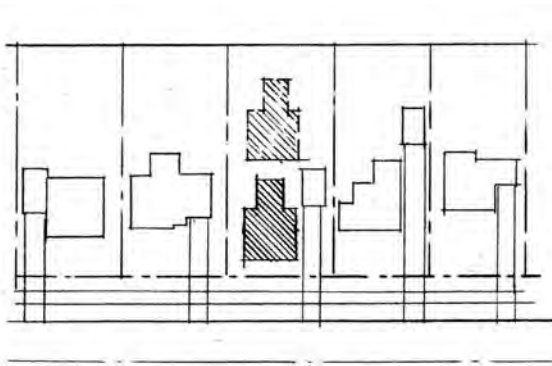

An extreme difference in setback from adjacent buildings is not appropriate.

9.5 New Development

9.5.2 Residential Area 9.5.2.2 Architectural Style



New buildings in the residential areas should reflect the historic built form of their historic neighbours.

Guidelines:

It's possible to build new houses that are highly compatible with heritage buildings. These recent houses were built in the Unionville Heritage Conservation District.



- Design houses to reflect one of the local heritage Architectural Styles. See Section 9.1.
- Hybrid designs that mix elements from different historical styles are not appropriate. Historical styles that are not indigenous to the area, such as Tudor or French Manor, are not appropriate.
- Use authentic detail, consistent with the Architectural Style. See Section 9.2.1.
- Research the chosen Architectural Style. See Section 10 for useful research sources.
- Use appropriate materials. See Section 9.8.

9.5 New Development

9.5.2 Residential Area

9.5.2.3 Scale and Massing



Design new houses to be consistent with the scale of neighbouring ones.



Don't design new houses that are inconsistent with the existing neighbourhood scale.

New residential construction in the residential villages should respect local heritage precedents in scale and massing. In almost every case, new construction will be replacement houses on existing built lots. Note: It is recommended in Section 7 that the zoning by-law be amended to recognize the smaller scale of historic village development as contrasted with modern suburban development.

Guidelines:

- New buildings should be designed to preserve the scale and pattern of the historic District.
- New houses should be no higher than the highest building on the same block, and no lower than the lowest building on the same block.
- As far as possible, modern requirements for larger houses should be accommodated without great increases in building frontage. For example, an existing 1½-storey house could be replaced by a 2-storey house with a plan that included an extension to the rear. This might double the floor area without affecting the scale of the streetscape.
- Follow the policies in Section 4.4 of this Plan concerning height and depth of buildings and garages.
- For garages, see Section 9.3.8.

9.5 New Development

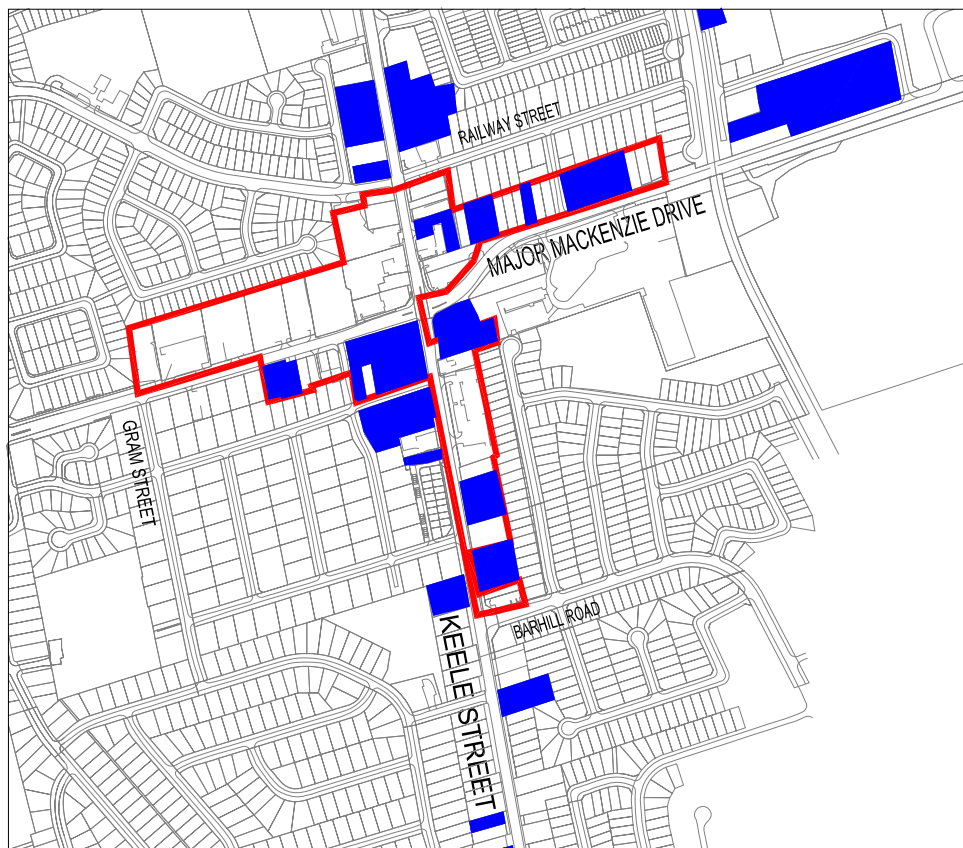

The Maple Commercial Core is defined by OPA 350 with the boundary as shown above. The shaded properties are heritage properties.

9.5.3 Commercial Core

9.5.3.1 Character

- The Maple Commercial Core, as defined by OPA 350, is larger than the historical commercial area which was more compact, and very close to the crossroads.
- The Maple Commercial Core includes 34 heritage properties.
- Except for the Lawrie Store on the southwest corner of Keele and Major Mackenzie, all of the heritage buildings were originally constructed as dwellings. Some have been converted to commercial use, but most remain dwellings.
- In the areas where the dwelling-form buildings predominate, the village pattern has persisted: lots are wide, and trees are a significant aspect of the streetscape.
- There are a number of newer commercial buildings. Some are large-footprint one- or two-storey plazas. In the 20-year horizon of this plan, these sites should be considered as having potential for intensification.
- Heavy traffic, on both Keele Street and Major Mackenzie Drive, is detrimental to pedestrian comfort, particularly where the sidewalk is close to the curb.
- For more detailed descriptions of the character of the streetscapes, see Appendix B.

9.5 New Development

9.5.3 Commercial Core

9.5.3.2 Objectives for guidelines for new development



A view south on Keele Street. Richmond Street intersects on the left just past the first building. Most of the shops are front-gable buildings in the traditional village commercial style.



The same intersection viewed from the south. The camera would be in front of Beaverbrook House. Both photos from the Vaughan Archives.

Overall Objectives

- Preserve existing heritage buildings.
- Ensure that new development respects and enhances existing heritage character and resources.
- Respect the historic residential areas.
- Develop a pedestrian-friendly commercial environment.
- The polices and guidelines for new development in the Commercial Core are suitable for all commercial sites within the district.

Building/Street Relationship

In order to create a commercially viable pedestrian environment, it should be the aim of new development to enhance the sense of security for pedestrians.

Guidelines:

- The use of on-street parking, grassed boulevards, cooperative connected parking arrangements and access, and connected pathways and open spaces between and at the rear of buildings are all supported in site planning of new developments. See site planning guidelines below.
- Entrances shall face the principal street. Corner entrances are encouraged for corner lots. Principal entrances will be flush with the sidewalk, and will comply with the Ontario Building Code and the Ontarians with Disabilities Act in their design.

9.5 New Development

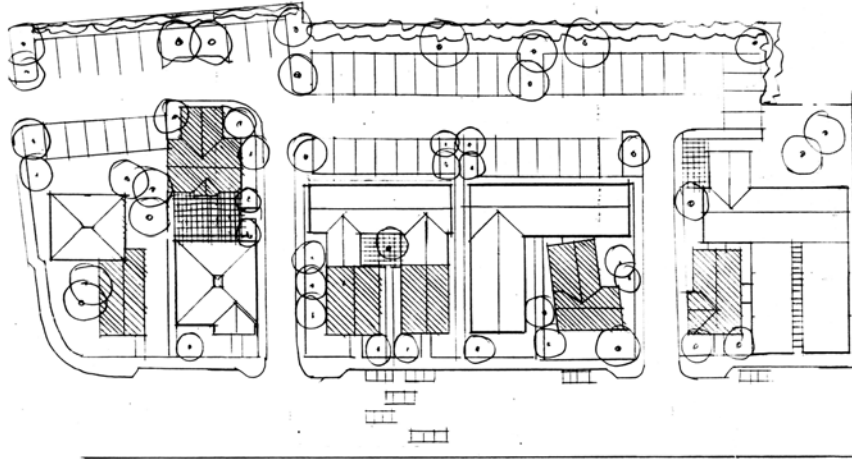

Preservation of heritage buildings, preservation of trees, complementary infill, connected parking to reduce the number of driveways, and parking lay-bys on the street are all elements that contribute to a pedestrian-friendly environment.

9.5.3 Commercial Core

9.5.3.3 Pedestrian Amenity

- The primary obstacle to the creation of a pedestrian-friendly village is the sense of insecurity produced by the fast and heavy traffic on Keele Street and Major Mackenzie Drive.
- The village form, with its front yards and varied setbacks, provides the opportunity for pedestrian-oriented spaces, away from the busy street. These spaces are vital elements in the creation of a pedestrian-friendly environment.
- On-street parking is a valuable traffic-calming measure, and its effect as a pedestrian amenity is even more significant. The sense of protection afforded by a row of parked cars is considerable, particularly where pedestrian space between buildings and curbs is limited. Many municipalities provide on street parking during off-peak hours, even on major arterial roads. It doesn't seem unreasonable to add Maple to the list.
- If on-street parking within the current right of way is denied by the Region, new development should be set back about 3m to allow space for lay-by parking to achieve the same sense of pedestrian protection.

9.5 New Development

9.5.3 Commercial Core

9.5.3.4 Site Plan Characteristics

The site plan characteristics of a village are different than those of a town.

The principal qualities found in a village are:

- The existence of sideyards, even on most commercial properties;
- A variety of frontyard setbacks, with purpose-built commercial buildings tending to be located at the streetline, and residential front yards ranging considerably in depth;
- The use of low fencing or planting to delineate all but the shallowest of residential front yards;
- The random presence of trees in front, side, and rear yards, providing a frame of clumps of greenery to the built form. This is in contrast to the commercial form of towns and cities, where trees are either absent, or arranged as linear boulevard planting.

New developments should be designed to respect and mimic the traditional village form.



Markham, above, grew into a town. There is a fairly continuous line of buildings, constructed on the street line. Kleinburg, below, remained a village. The buildings are separated and front-yard setbacks vary. Trees provide a frame for the buildings, growing in front of, beside, and behind them.



9.5 New Development

9.5.3 Commercial Core 9.5.3.5 Site Plan Guidelines

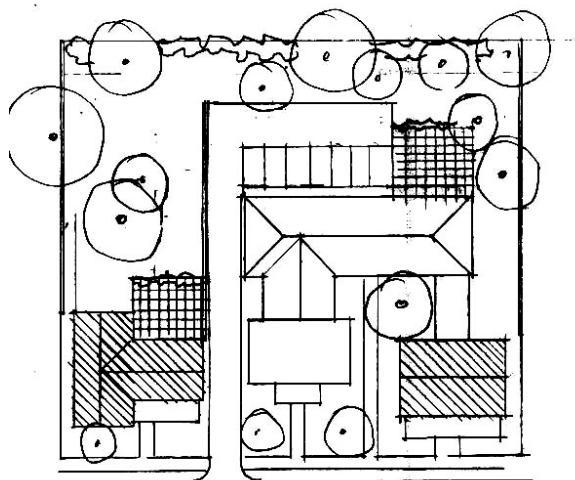

Infill developments should preserve existing heritage structures and existing mature trees. Set-backs should be varied, in keeping with the historic village character.

The example shown above maintains a planted buffer strip at the rear, where it abuts residential properties.

Sites with Heritage Buildings:

Most of the street frontage in the Commercial Core is rich in existing heritage buildings. Intensification should respect the existing heritage character of the streetscape.

Guidelines:

- All existing heritage buildings should be conserved.
- The Zoning By-law for Maple should be revised to ensure that developments which include or abut existing heritage buildings respect, give prominence to, and not overwhelm the heritage buildings. Consideration should be given to the use of angular planes, related to the heritage building height, for adjacent new construction.
- Existing mature trees should be preserved, and new tree planting should be designed to reflect the traditional village pattern. Trees should be planted in front of and beside new buildings and, where possible, behind them. Even when planted in an island in a parking area, these trees will contribute to the village character.
- Variety in front-yard setbacks should be employed. This is in keeping with the character of a village, and also provides areas with a sense of refuge from the busy street.
- Developments with substantial frontages should be designed to provide a variety of setbacks, at the village scale, on the site.
- Front-yard areas created by building setbacks should be planted and/or fenced to the greatest extent allowed by reasonable access to the businesses. A predominance of paving in front-yard areas is not in keeping with the village character.
- Where front-yard patios are installed, they should take the character of a fenced front yard, not a suburban deck with a railing; in-ground planting should be used to soften the landscape in such patios.
- Trees should be native species. See Section 9.7.

9.5 New Development

9.5.3 Commercial Core

9.5.3.5 Site Plan Guidelines Cont'd

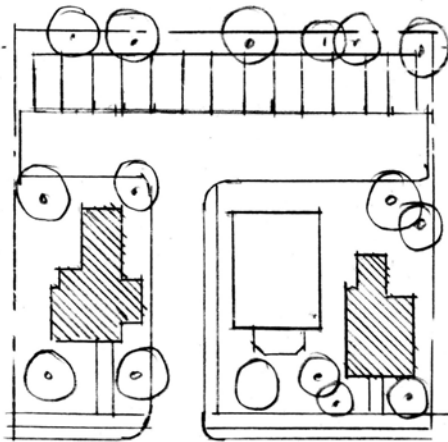

Preservation of the setting is one of the basic principles of conservation.

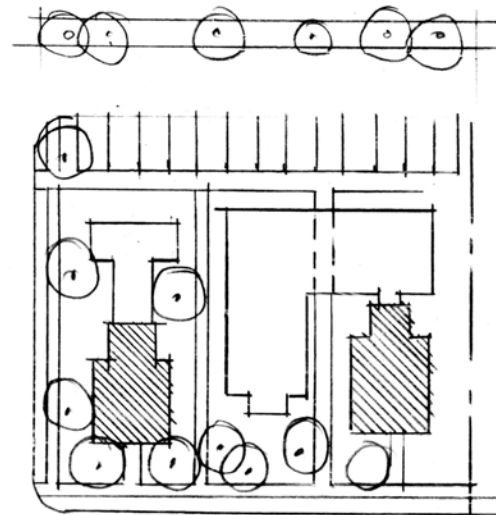

Scale of frontage matches heritage buildings. Rear part of new building could be higher if designed not to overwhelm heritage buildings.

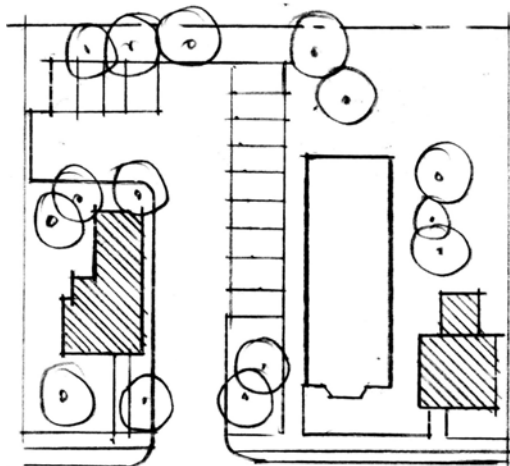

A compromise solution that preserves scale of street frontage and the spatial variety of a village plan.

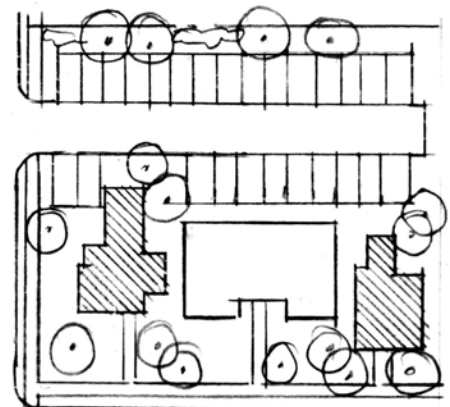

A wider building, but with smaller elements in scale with heritage buildings. Setbacks respect the variety found in the neighbouring lots.

Sites with Heritage Buildings:

Possible site plans for a variety of contexts are shown on the left.

- Site plans respect the varied setbacks typical of a village and respect the existing heritage buildings.
- New buildings are separate from heritage buildings, or the connections are set well back from the frontage.
- Wide elevations are broken up to reflect the scale of width of the heritage buildings.
- Set backs create pedestrian comfort zones away from traffic.
- Planting and fencing are in keeping with the character of historic villages. Trees are planted in front, beside, and behind buildings.

9.5 New Development

9.5.3 Street Commercial Core 9.5.3.5 Site Plan Guidelines Cont'd

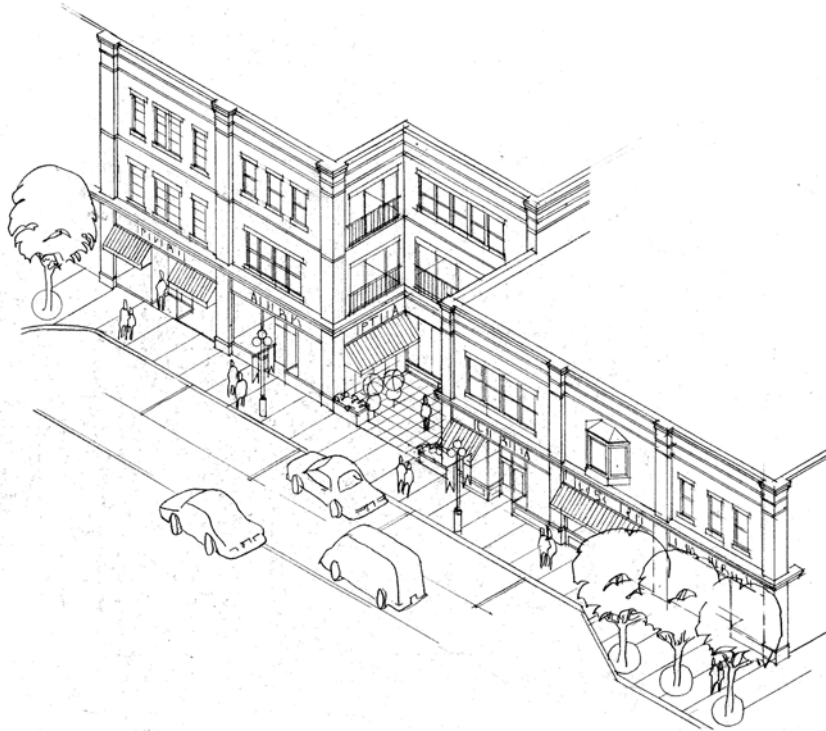

New development based on town commercial buildings. The scale of the building is broken into elements 20 metres wide, and the linking element is set back to create a zone of enhanced pedestrian comfort. A parking lay-by also enhances the sense of pedestrian security, and boulevard trees soften the environment

Large sites without heritage buildings:

On larger sites, without existing heritage buildings, intensification will mean larger redevelopment projects. It is important that these projects respect the overall character of the village, and that their rhythm and scale are integrated with the smaller scale of the historic village.

Guidelines:

- Frontages of designs based on larger heritage precedents, such as town commercial buildings and hotels, should be broken into elements of no more than 20 metres in width.
- Linking elements between such frontages should be set back to provide an area of pedestrian refuge, as a landscaped element, patio, or seating area.
- Landscaping should be provided, including planters, benches and waste receptacles as integral to the design.

9.5 New Development

9.5.3 Commercial Core

9.5.3.6 Scale and Massing



NORTH ELEVATION

These proposal sketches all show projects that respect the scale and height of the existing heritage buildings in Maple.

Scale and massing shall respect the character of the historic Village.

Guidelines:

- Maximum façade height of 3 storeys with a maximum building height of 11.8 metres.
- Height and massing should respect the 1 to 2- storey residential properties when they are adjacent. Mansard roofs are not suitable.
- The ground floor ceiling height should be a minimum of 4.5 metres along all primary commercial frontages.
- A minimum of 75% glazing for retail window display will be pursued for commercial ground floor.
- The height of window and door articulation on the commercial ground floor will respond to the greater ground floor to ceiling height and should appear in proportion with the overall height and massing of the building.
- A high quality of commercial and “store front” design is recommended. Visibility along the commercial ground floor in terms of composition of windows, entryways and materials is encouraged.
- All buildings and commercial units fronting onto a primary or secondary street must have an entrance fronting the primary or secondary street.
- Commercial building entrances should be easily identifiable and appropriately signed.
- The building base occurring along commercial frontage may exhibit a material change from that exhibited along the building mid section above. The use of spandrel glazing on the building will not be permitted.
- Integrated vehicle connections such as arched ground floor passage ways may be suitable.

9.5 New Development



This photograph from Cobourg shows a new building in the foreground, which is modeled on the historic buildings farther along the street.

In Maple, this kind of town-style commercial buildings should be broken up, with a set-back for every third or fourth bay. See the site planning guidelines in Section 9.5.3.5.

9.5.3 Commercial Core

9.5.3.7 Architectural Style

Historic buildings in the Commercial Core consist of a mix of purpose-built commercial structures and house-form residential. Some residential buildings had storefronts added after construction, even at a very early date. Most of the buildings, even purpose-built ones, had gable roofs, although some had “false fronts” to mimic flat roofed town commercial buildings.

New buildings should reflect one of these heritage styles, particularly in its street-front aspect

Guidelines:

- New buildings should reflect a suitable local heritage style. Use of a style should be consistent in materials, scale, detail, and ornament.
- Do not use hybrid designs that mix elements from different historical styles.
- Use authentic materials. In most cases this means brick, with stone sills and brick or stone lintels.
- Use Section 9.1 for preliminary guidance on styles.
- Use Section 9.2 for further preliminary guidance on details of design and construction
- It is highly recommended that owners engage design professionals skilled in heritage work for new buildings in the District.

9.5 New Development

9.5.3 Commercial Core

9.5.3.8 Storefronts



As noted under Architectural Style, above, historic commercial buildings may have been purpose-built or converted from residences. This is typical of a village commercial streetscape, and differentiates it from shopping areas in larger towns and cities. As a result, there is a variety of heritage precedents available for the design of new shopfronts.

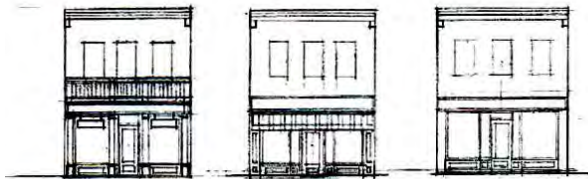

Historical conversions of residential buildings to commercial use often inserted a large window opening, perhaps on only one side of a central door, rather than full width storefront. More recent conversions often leave the original residential window openings in place, if the business doesn't require large display windows.

Guidelines:

- Storefront design should reflect local historic precedents. Design elements within any chosen precedent should be consistently applied.
- Full-width porches are appropriate elements in storefront design.
- Retractable awnings are appropriate. Rigid awnings and fixed canopies are inappropriate.
- Use of traditional wood and glass construction for storefronts is encouraged.
- If modern materials are used, they should be detailed to replicate traditional designs in scale, proportion and architectural effect. For example, the use of wood trim at jambs, posts, and panels can enhance the heritage effect of standard storefront and glazing systems.
- Both *Preservation Briefs* and *Architectural Conservation Notes* have information on heritage storefronts. See Section 9.3.2.

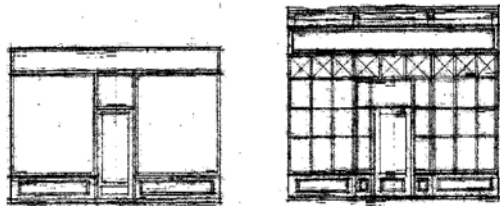

The classic late-19th Century shopfront featured tall glazing, a panelled wood base, and a narrow moulded sign fascia above.

9.5 New Development

9.5.3 Street Commercial Core

9.5.3.9 Signage



Moulded signbands integrated with historic storefronts, small soffit signs above or below porch fascias, and flat externally illuminated wall signs are appropriate in the District.



Signs that are modern in form, too large, or that obscure architectural detail are not appropriate in the District.

Guidelines:

The City of Vaughan Sign By-law governs. It will be stringently applied.

- Integrate signage with the design of the storefront, based on historical precedent.
- Back-lit or internally illuminated signs, including awning signs, are not appropriate.
- Neon and readograph signs are not appropriate.
- Third-party signs are not appropriate.
- Awning signs, other than lettering, no more than 6" high, on awning skirts, are not appropriate.
- Ground signs are without heritage precedent and are generally not appropriate. If other sign types would obscure architectural detail on a heritage building, a low ground sign, no higher than 1.0 metre, is acceptable.
- Directory ground signs, listing tenants of a commercial development, are not appropriate.
- Replacement of existing non-conforming signage should be included as part of any work undertaken on properties in the District.

9.6 Streetscape Work

9.6.1 Overview

Work within the road allowance should be designed and executed to meet modern requirements, amenity, and convenience, without detriment to the heritage character of the District. This work is either undertaken by public authorities, as in the case of roadside planting and the construction of roads, curbs, sidewalks, lighting, and road signage or it is subject to approval by public authorities, as in the case of BIA installations, newspaper boxes, and tourism information or identity signage.

District Identity

Installations within the road allowances have a significant effect on the experience of the heritage character of the District and the establishment of a sense of identity. The use of a consistent design vocabulary at the various scales and in the various kinds of road allowance work reinforces the District's identity and supports its economic role as a place of unique historical character in the community. Permits are required for the installation of items such as sidewalks, curbs, paving, street and pedestrian lighting, benches, tree grates, tree guards, trash receptacles, recycling bins, and parking equipment.

Contexts

Maple possesses two distinct contexts: the Commercial Core, and the Residential Areas. The goals of the Guidelines for streetscaping are:

- Enhancing historical character of the road allowances in the Residential Areas.
- Creation of a pedestrian-friendly shopping environment in the Commercial Core.
- Establishing identity through gateways, signage, and markers.

9.6 Streetscape Work



Church Street has a curbless rural profile (above). The grassed and treed boulevard on Keele Street (below) creates a pedestrian friendly environment.



9.6.2 The Residential Streets

Roadways

Church Street, Jackson Street, Hill Street, and Station Street have a curbless rural profile. Other residential areas have grassed boulevards, to a great extent. These are an important part of the heritage character of these streets

Guidelines

- The rural profile should be preserved where it exists.
- Over time, grassed boulevards should be provided where they don't already exist.

Planting

Rural villages are planted informally, with a mix of trees and deciduous shrubs.

Guidelines

- Maintain a village character in street planting. The linear urban planting pattern of regularly spaced boulevard trees is not appropriate here.
- See Section 9.7 for suggested species.

9.6 Streetscape Work

9.6.3 Commercial Core



Creation of a pedestrian-friendly core faces many challenges.

Overview

Creation of a pedestrian-friendly commercial environment is the most important objective of streetscape work in the Commercial Core. Pedestrian amenity is discussed in Section 9.5.3.3, above. Specific improvements, including private and street parking are also discussed under Site Planning, in Sections 9.5.3.4 and 9.5.3.5.

Streetscape installations are an important aspect of meeting the objectives of conserving the heritage character, reducing the impact of traffic on the pedestrian environment, and creating a viable commercial destination.

Early 20th-century photographs of Maple show streetscapes very different from today's. An accurate "historical reproduction" would exclude automobiles, paving, lighting, highway signs, bollards, and benches. It's obvious that a lively commercial area requires all of these things, some of them because they enable and enhance public use and commercial activity in the village core, many of them because regulations and standards govern the design of traffic systems, lighting levels, and so on. There is an inherent historical ambiguity in a Heritage District that must be addressed when evaluating the design of these modern installations. The following principles apply to such an evaluation:

9.6 Streetscape Work

9.6.3 Commercial Core Cont'd

Principles

1. Adapt to the automotive streetscape: As the list of modern artifacts previously detailed shows the automobile and its infrastructure account for much of the visible non-heritage installations in the District. There is a built-in division of the streetscape in its historical aspect: it is inescapably modern from curb to curb. Modern accessories like waste receptacles and street lighting should be placed near to the curb, where they form a transition band between the heritage experience of the buildings and the modern experience of the roadway.

2. Don't accentuate non-heritage installations: Human perception is very good at filtering out unimportant and repetitive information. The modern enthusiasm for heritage has produced a host of "old-fashioned" products. Many of these are poorly executed and overly fussy. As a result, they call undeserved attention to themselves and the attention, thus directed, detects the fraud. Often, a very plain modern item will fade into the recesses of perception and be less intrusive than a deliberately "historical" version.

3. Maintain historical integrity: Even when they don't represent an accurate reconstruction, it is important to choose "historical" items in the context of history. For example, the streetlighting of 1890 can't be reconstructed because there was none. The designer should bear in mind that Maple was a modest hamlet and ask, "If the village HAD installed early lighting, what sort of fixtures would have been chosen?" They would have been simple and functional, and would not have had the ornate qualities of lighting for a big-city promenade.

Applying artificial heritage elements to modern items only calls attention the inauthenticity of the exercise. It's better to choose inobtrusive designs. In the example below, the bus shelter doesn't work, but the waste container does.



Lighting

The future installation of lighting fixtures in the Commercial Core should be selected so as to comply with the principles outlined above. When replacement becomes necessary, due to aging or upgraded standards for light levels and “dark skies”, fixtures of a similar simplicity should be chosen.

Street Furniture

Selection of street furniture should follow the principles outlined above. In general, items that might have appeared in a village environment should be selected for authenticity. Items that are modern interjections should be selected for unobtrusiveness. It is recommended that street furniture items be black, as it helps keep these items in the visual background, and is an historic colour for painted metal items like light posts and bench ends.

Benches should be the traditional flat-slat type with cast metal ends, in a simple design. Bench castings are available with cast-in or bolted-on lettering, which could serve as a District identity marker.

Waste and Recycling Bins should have a simple design, and should be constructed so that plastic garbage-bag liners are not visible. Box-type recycling bins bearing advertising are not appropriate. The design of the waste and recycling bins should be such that they can be readily emptied from the side and not collect rain water.

Tree Guards should have a simple design, compatible with the design of waste and recycling bins.

Planters were not part of the historic streetscape but they have become established as “softeners” in business areas everywhere. In that sense, they resemble the non-functional “heritage” dormers, cupolas, and gazebos that flourish on modern shopping plazas. To the extent that planters are part of the modern commercial landscape, they should take a form that reflects the traditional garden pattern of rectangular beds. It is generally preferable to use in-ground planting, rather than planters in locations not susceptible to street salt spray and other contaminants. Hanging flower baskets should be minimized, since they were not part of the historic streetscape, and have become a symbol of urban shopping districts.

9.6 Streetscape Work

Gateways

Gateway markers at principal entrances to the District would serve to reinforce its identity and to promote the District as a place of unique historical character in the community and region. Markers should be placed so that they reinforce an existing sense of entrance, rather than at the exact point that a roadway crosses the District boundary.

Guidelines:

- Markers should be placed: At the four principal entry points on Major Mackenzie Drive and Keele Street.

9.7 Landscaping

9.7.1 Planting

No heritage permits are required for planting activities, but voluntary compliance with the guidelines in this Section can help maintain and enhance the natural heritage of the Maple and its valley.

Suitable new planting and management of existing flora are a primary means of ensuring the health of the entire ecosystem: plants contribute to stormwater and groundwater management, erosion control, and provide habitat and nutrition for wild fauna.

Guidelines:

- Maintain health of mature indigenous tree by pruning and fertilizing.
- Over time, remove unhealthy, invasive and non-indigenous species.
- Site buildings and additions to preserve suitable mature trees.
- Protect and preserve mature trees during construction.

Suitable indigenous species:

- Sugar Maple, Red Oak, Basswood, Silver Maple, Bitternut, Butternut, White Pine, Hemlock, American Elm, Red Maple, Bur Oak, White Spruce.

It is recognized that because of the urban environment and site conditions the use of non indigenous species may be suitable for road side planting. These include:

- *Acer platanoides* 'Columnare', *Tilia cordata*, *Aesculus glabra*, *Quercus alba*, *Gymnocladus dioicus*, *Syringa reticulata* and *Pyrus calleryana*.

Other suitable planting species include:

Day Lilies, Peonies, Irises, Echinacea, Campanula, Aconitum, Veronica

Unsuitable species:

- Manitoba Maple, Hawthorn, Black Locust, and Buckthorn tend to be invasive.
- Invasive, non native ornamental species, particularly Norway Maple cultivars.

Street tree planting on arterial roads should conform with Region of York guidelines. Please refer to 'Tree Planting Design Criteria' within the Region's Road Design Guidelines handbook. In general, street trees should be hardy, salt-tolerant 60 mm caliper balled and burlapped specimens, spaced at 8-12 metres on centre, planted 3 metres from any curb or utility pole and offset 1 metre from any sidewalk and 3 metres from any driveway

9.7 Landscaping

9.7.1 Warning! Invasive Plant Species



Of the roughly 2600 identified vascular plant species that grow wild in Ontario, more than 25% are aliens or exotics not native to the province. These importations have been going on since Europeans first arrived, either as deliberate introductions or as stowaways in cargoes, ballasts, and debris. However and whenever they arrived, these species have found hospitable ecological niches. Once established they make use of the plant world's full array of propagation strategies. Without the pests and competitors of their native environments, many are able to out-compete native species, and may seriously threaten entire native ecosystems, replacing a host of native plants that together provided food and habitat for native wildlife. The Federation of Ontario Naturalists has more detailed information on invasive species and their control on their website.

Guidelines:

Avoid these invasive plant species:

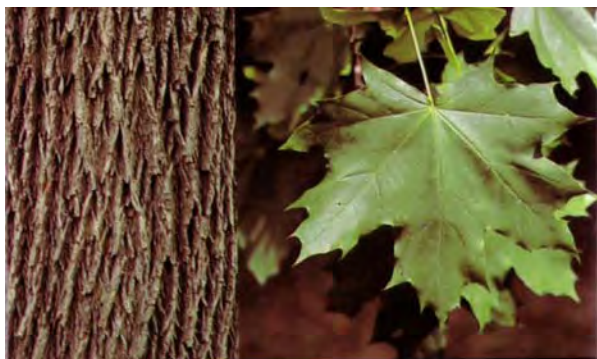

Two prime invaders are Purple Loosestrife, above, and Norway Maple, below. Both have been popular for garden and street planting, and both have proven to be highly invasive. Images from Audubon Society Field Guides.

- Purple Loosestrife
- Norway Maple
- European Birch
- Highbush Cranberry
- European Mountain Ash
- Privet
- White Mulberry
- Horse Chestnut
- Scots Pine
- Crown Vetch
- Periwinkle
- Dame's Rocket
- Winter Cress
- Silver Poplar
- Siberian Elm
- Himalayan Balsam
- Russian Olive
- Sweet Woodruff

9.8 Building Materials Checklist

All construction visible from the exterior requires a Heritage Permit. Visible materials should conform to the following standards:

9.8.1 Heritage Buildings

Appropriate Materials:

Exterior Finish:	Smooth red clay face brick, with smooth buff clay face brick as accent, or in some instances brick to match existing conditions. Wood clapboard, 4" to the weather. Smooth, painted, wood board and batten siding.
Exterior Detail:	Cut stone or reconstituted stone for trim in brick buildings. Wood shingles, stucco, or terra-cotta wall tiles in gable ends. Painted wood porches, railings, decorative trim, shutters, fascias and soffits. Painted wood gingerbread bargeboards and trim, where appropriate to the design.
Shopfronts:	Wood frames, glazing bars, and panels with glazed wood doors are preferred. Metal shopfronts, detailed and proportioned to be compatible with heritage shopfronts, are acceptable.
Roofs:	Hipped or gable roof as appropriate to the architectural style. Cedar, slate, simulated slate, or asphalt shingles of an appropriate colour. Standing seam metal roofing, if appropriate to the style. Skylights in the form of cupolas or monitors are acceptable, if appropriate to the style.
Doors:	Wood doors and frames, panel construction, may be glazed. Transom windows and paired sidelights. Wood french doors for porch entrances. Single-bay, wood panelled garage doors.
Windows:	Wood frames; single or double hung; lights as appropriate to the architectural style. Real glazing bars, or high-quality simulated glazing bars. Vertical proportion, ranging from 3:5 to 3:7.
Flashings:	Visible step flashings should be painted the colour of the wall.

9.8 Building Materials Checklist

9.8.1 Heritage Buildings

Inappropriate Materials

Exterior Finish:	Concrete block; calcite or concrete brick. Textured, clinker, or wire cut brick, except where their use is consistent with existing conditions. Precast concrete panels or cast-in-place concrete. Prefabricated metal or plastic siding. Stone or ceramic tile facing. “Rustic” clapboard or “rustic” board and batten siding; wood shake siding.
Exterior Detail:	Prefinished metal fascias and soffits. “Stock” suburban pre-manufactured shutters, railings, and trims. Unfinished pressure-treated wood decks, porches, railings, and trim.
Shopfronts:	Standard metal shopfronts and pre-finished metal spandrel material. Frameless tempered glass shopfronts.
Roofs:	Slopes or layouts not suitable to the architectural style. Non-traditional metal roofing such as pre-finished or corrugated metal. Modern skylights, when facing the street.
Doors:	“Stock” suburban door assemblies. Flush doors. Sidelights on one side only. Aluminum storm and screen doors. Sliding patio doors. Double-bay, slab, or metal garage doors. Generic or Stock stained glass window assemblies for doorlights and sidelights.

9.8 Building Materials Checklist

9.8.1 Heritage Buildings

Inappropriate Materials

- Windows: Large “picture” windows.
Curtain wall systems.
Metal, plastic, or fibreglass frames.
Metal or plastic cladding.
Awning, hopper, casement or sliding openers. Casement windows may be appropriate on California Bungalow styled buildings.
“Snap-in” or tape simulated glazing bars.
- Flashings: Pre-finished metal in inappropriate colours.

9.8.2 Non-Heritage Buildings

Note: If using the Historical Conversion approach, described in Section 9.4.1.1, follow the Heritage Building Checklist, above.

Appropriate Materials

- Exterior Finish: Use materials compatible with the original design.
- Roofs: Slopes and layouts compatible with the original design.
- Doors: Use materials and designs compatible with the original design.
- Windows: Use windows compatible with the original design.